



Eastern Oregon University 8th Street Improvement Project June 22 - August 28 2015

**Bid Set
06/13/15**

PLACE 
735 NW 18th Ave.
Portland, OR 97209

**EASTERN OREGON
UNIVERSITY**



Eastern Oregon University La Grande, Oregon 8th Street Improvements Project

K Avenue

University Blvd.

Site Access

Area of Work

Site Access

I Avenue

6th Street

12th Street

Site Access



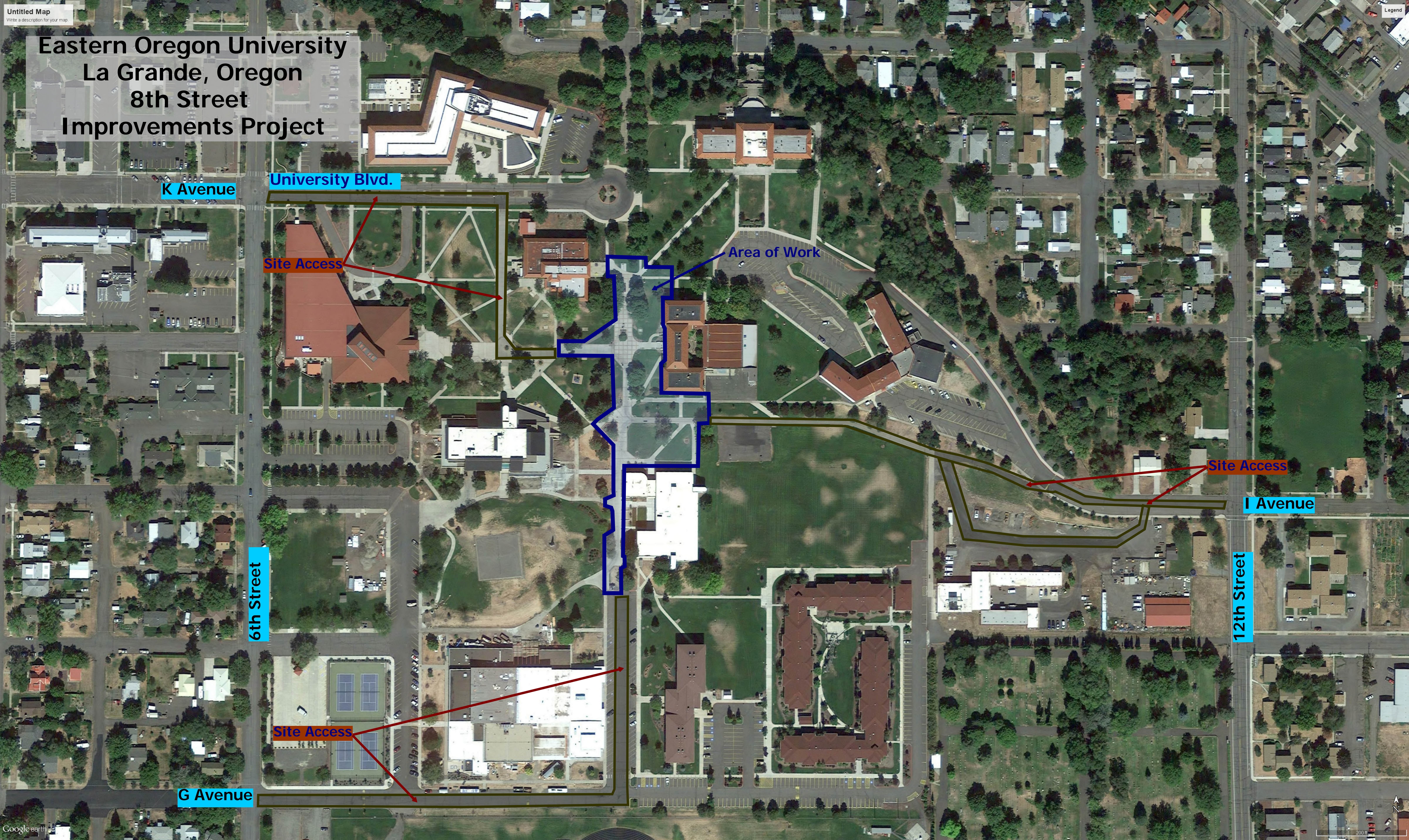

















G Avenue



TOPOGRAPHIC SURVEY
 EASTERN OREGON UNIVERSITY
 8TH STREET ADDENDUM

SCALE: 1"=40'

LEGEND

-  Control Point
-  Finish Floor Elevation
-  Tree
-  Catch Basin
-  Fire Hydrant
-  Manhole
-  Irrigation Control Valve
-  Water Valve
-  Gas Valve
-  Emergency Phone
-  Light Pole
-  Curb Cut / ADA Ramp
-  Vault
-  Contours (0.5 ft. interval)
-  Electrical Transformer
-  Water Meter
-  Telephone Riser
-  Electric Junction Box
-  Spot Elevations
-  Tree Protection

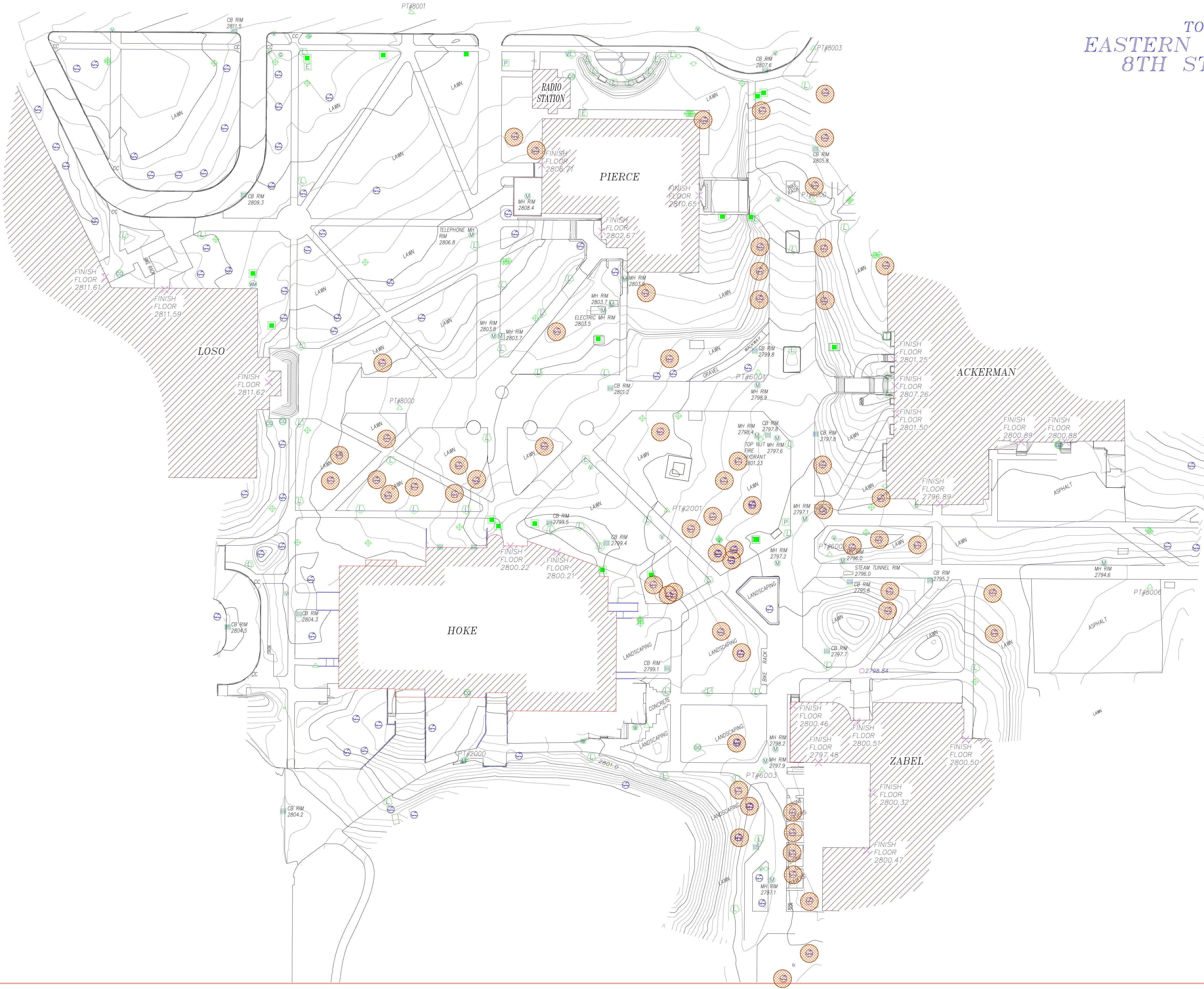

Bid Set
06/13/15

Improvements Project
 Reference Survey

Landscape Plans
L-01

PLACE
 735 NW 18th Ave.
 Portland, OR 97209



TOPOGRAPHIC SURVEY
 EASTERN OREGON UNIVERSITY
 8TH STREET ADDENDUM

SCALE: 1"=40'

LEGEND

- Control Point
- Finish Floor Elevation
- Tree
- Catch Basin
- Fire Hydrant
- Manhole
- Irrigation Control Valve
- Water Valve
- Gas Valve
- Emergency Phone
- Light Pole
- Curb Cut / ADA Ramp
- Vault
- Contours (0.5 ft. interval)
- Electrical Transformer
- Water Meter
- Telephone Riser
- Electric Junction Box
- 2700.25 Spot Elevations

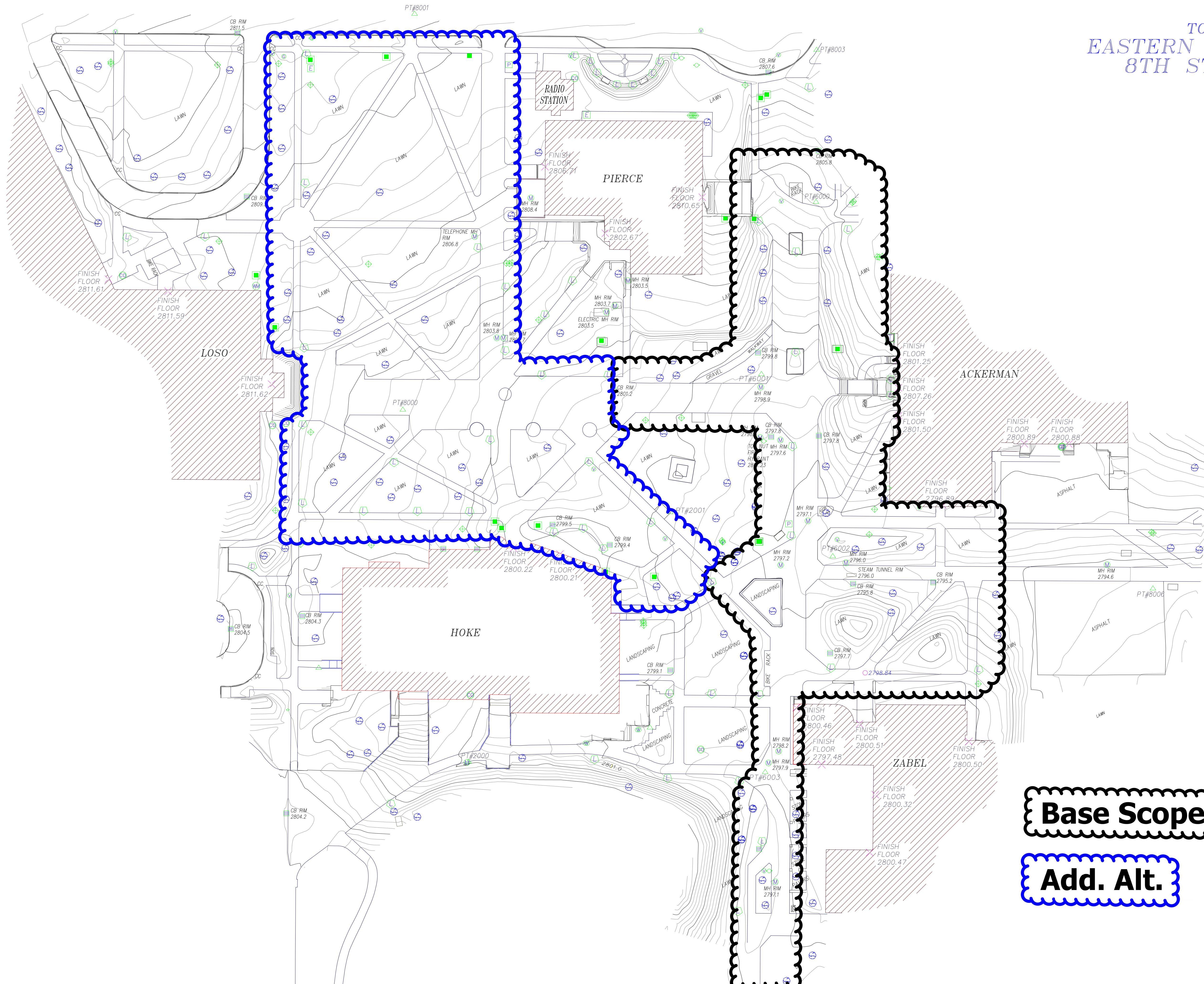

Base Scope

Add. Alt.

**Bid Set
06/13/15**

**EOU 8th Street
Improvements Project
Area of Work
Landscape Plans
L-02**

PLACE
 735 NW 18th Ave.
 Portland, OR 97209

TOPOGRAPHIC SURVEY
 EASTERN OREGON UNIVERSITY
 8TH STREET ADDENDUM

SCALE: 1"=40'

LEGEND

- Control Point
- Finish Floor Elevation
- Tree
- Catch Basin
- Fire Hydrant
- Manhole
- Irrigation Control Valve
- Water Valve
- Gas Valve
- Emergency Phone
- Light Pole
- Curb Cut / ADA Ramp
- Vault
- Contours (0.5 ft. interval)
- Electrical Transformer
- Water Meter
- Telephone Riser
- Electric Junction Box
- Spot Elevations
- Tree Protection

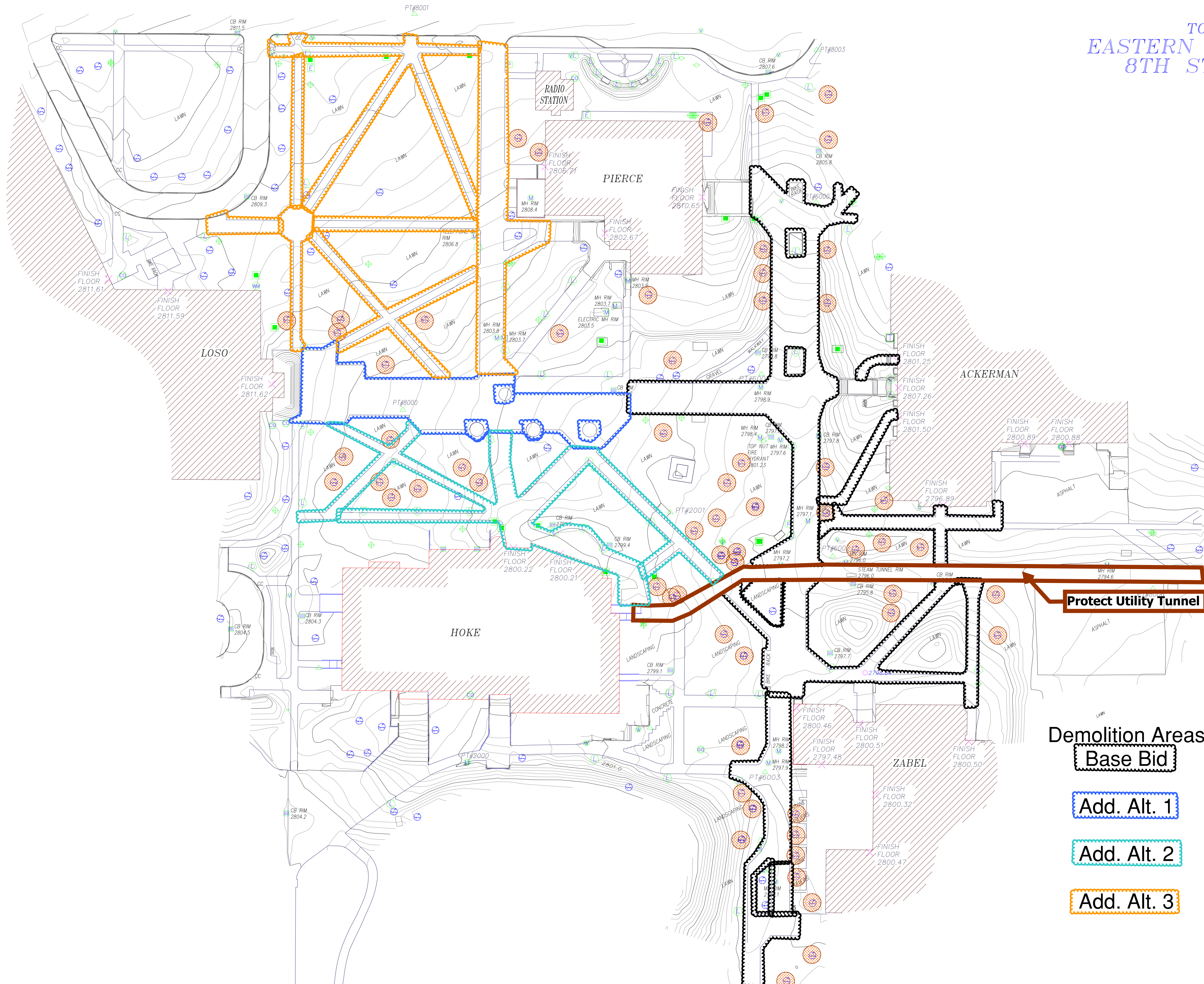

- Demolition Areas
- Base Bid
 - Add. Alt. 1
 - Add. Alt. 2
 - Add. Alt. 3

Bid Set
06/13/15

EOU 8th Street
 Improvements Project
Demolition Areas
Landscape Plans
L-03

PLACE
 735 NW 18th Ave.
 Portland, OR 97209

EO
 EASTERN OREGON
 UNIVERSITY

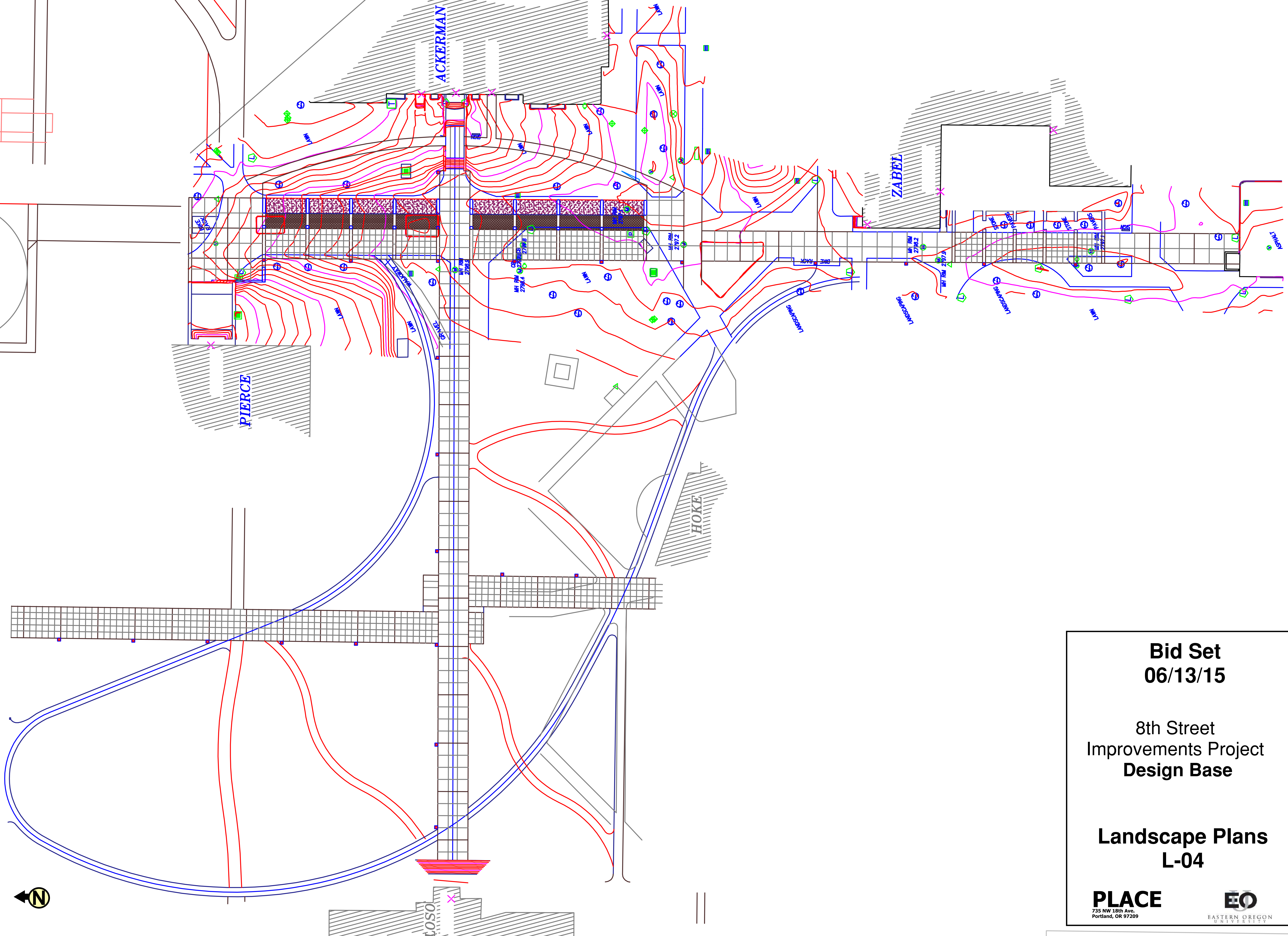

**Bid Set
06/13/15**

**8th Street
Improvements Project
Design Base**

**Landscape Plans
L-04**

PLACE
735 NW 18th Ave
Portland, OR 97209

EO
EASTERN OREGON
UNIVERSITY

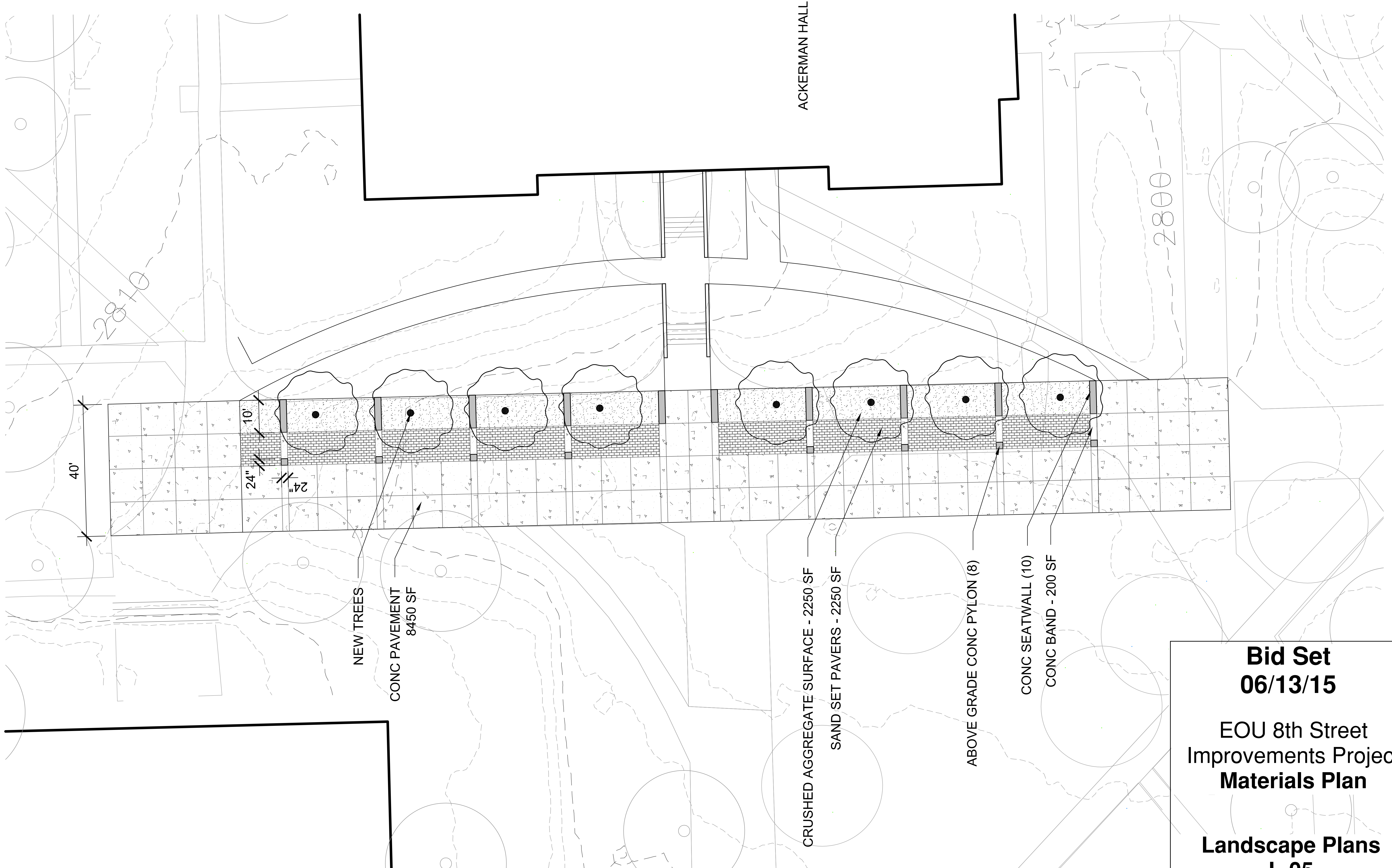

ACKERMAN HALL

NEW TREES

CONC PAVEMENT
8450 SF

CRUSHED AGGREGATE SURFACE - 2250 SF
SAND SET PAVERS - 2250 SF

ABOVE GRADE CONC PYLON (8)

CONC SEATWALL (10)
CONC BAND - 200 SF

**Bid Set
06/13/15**

**EOU 8th Street
Improvements Project
Materials Plan**

**Landscape Plans
L-05**

PLACE
735 NW 18th Ave.
Portland, OR 97209

EO
EASTERN OREGON
UNIVERSITY

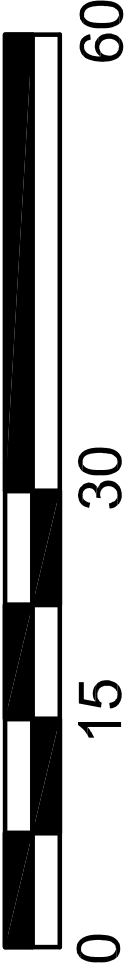
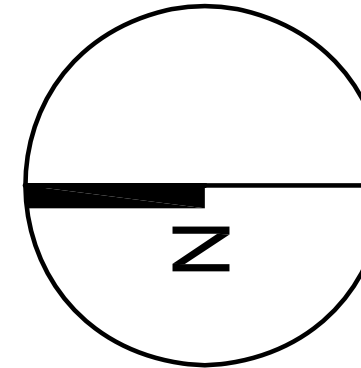

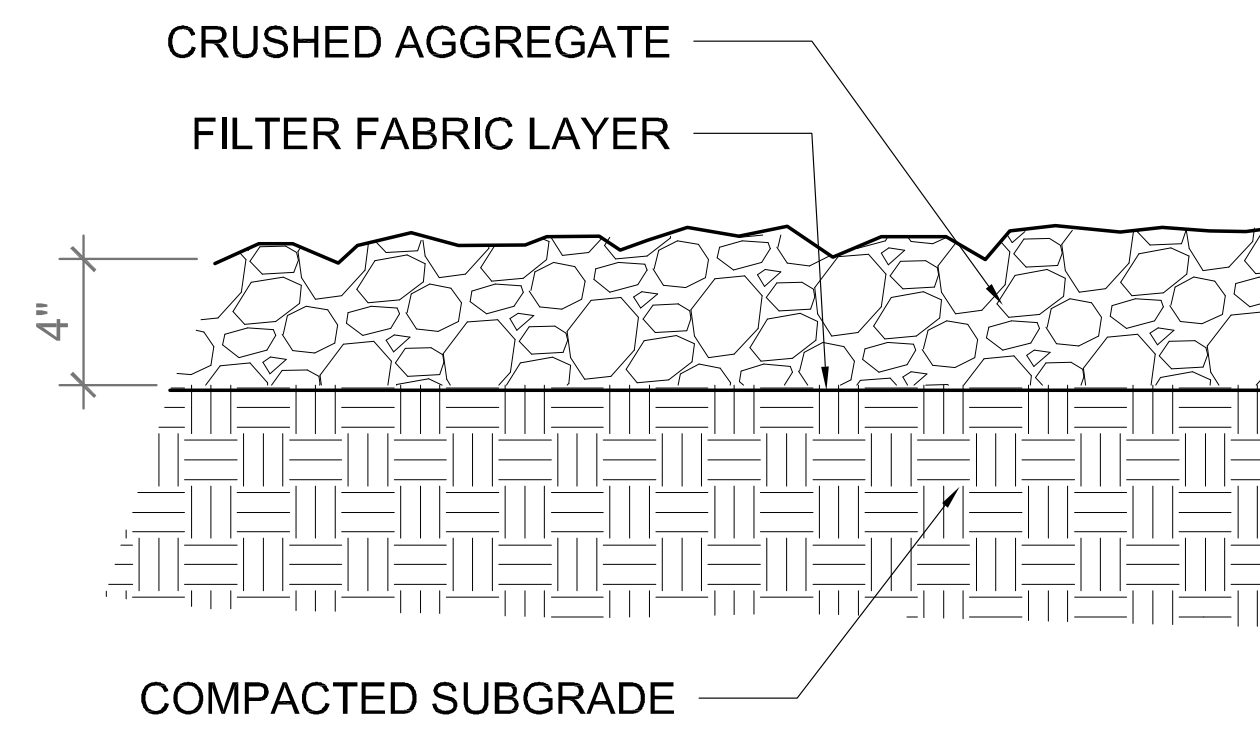

4 CRUSHED AGGREGATE SURFACE
 NTS

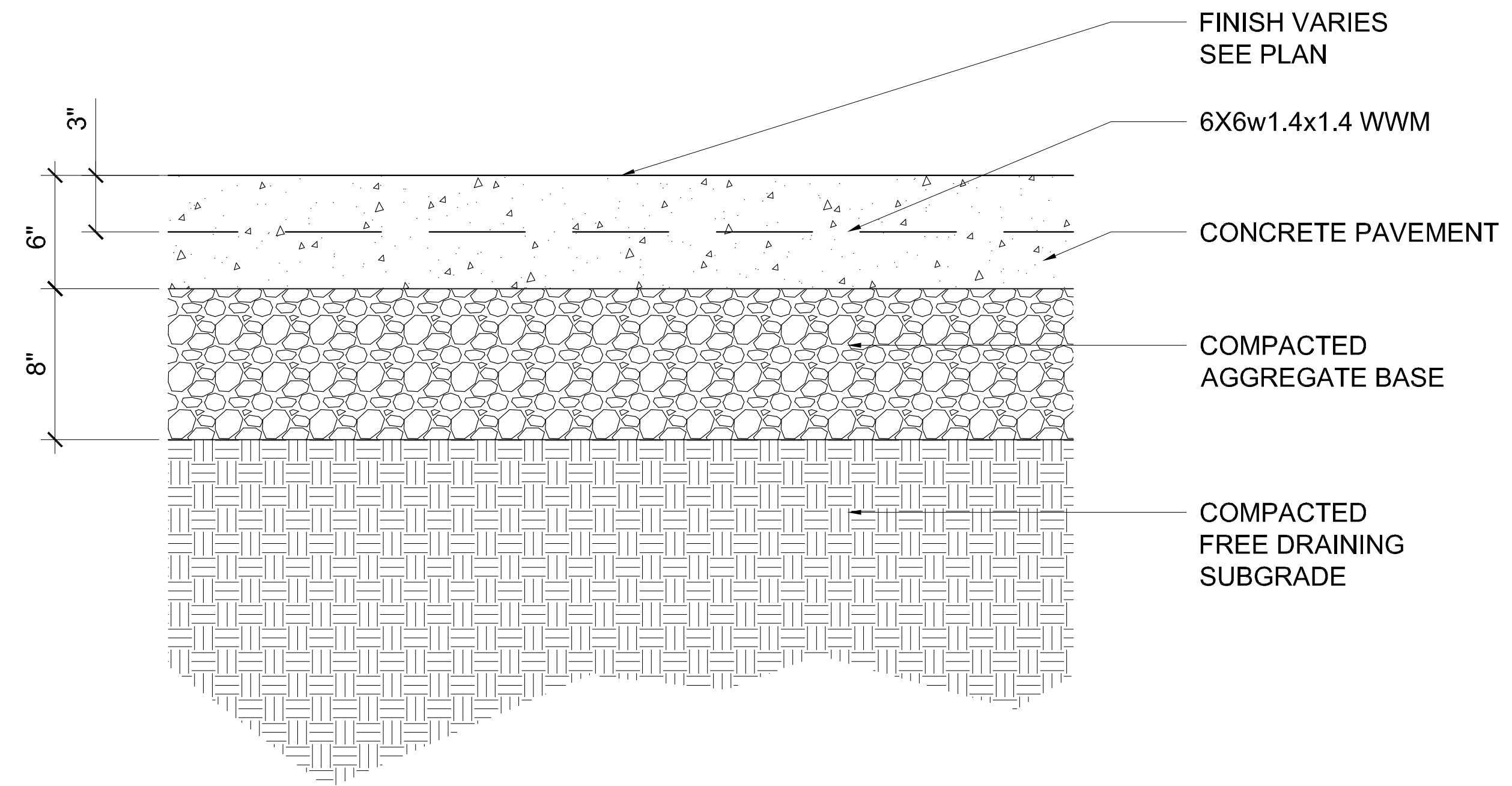

1 CONCRETE PAVEMENT
 NTS

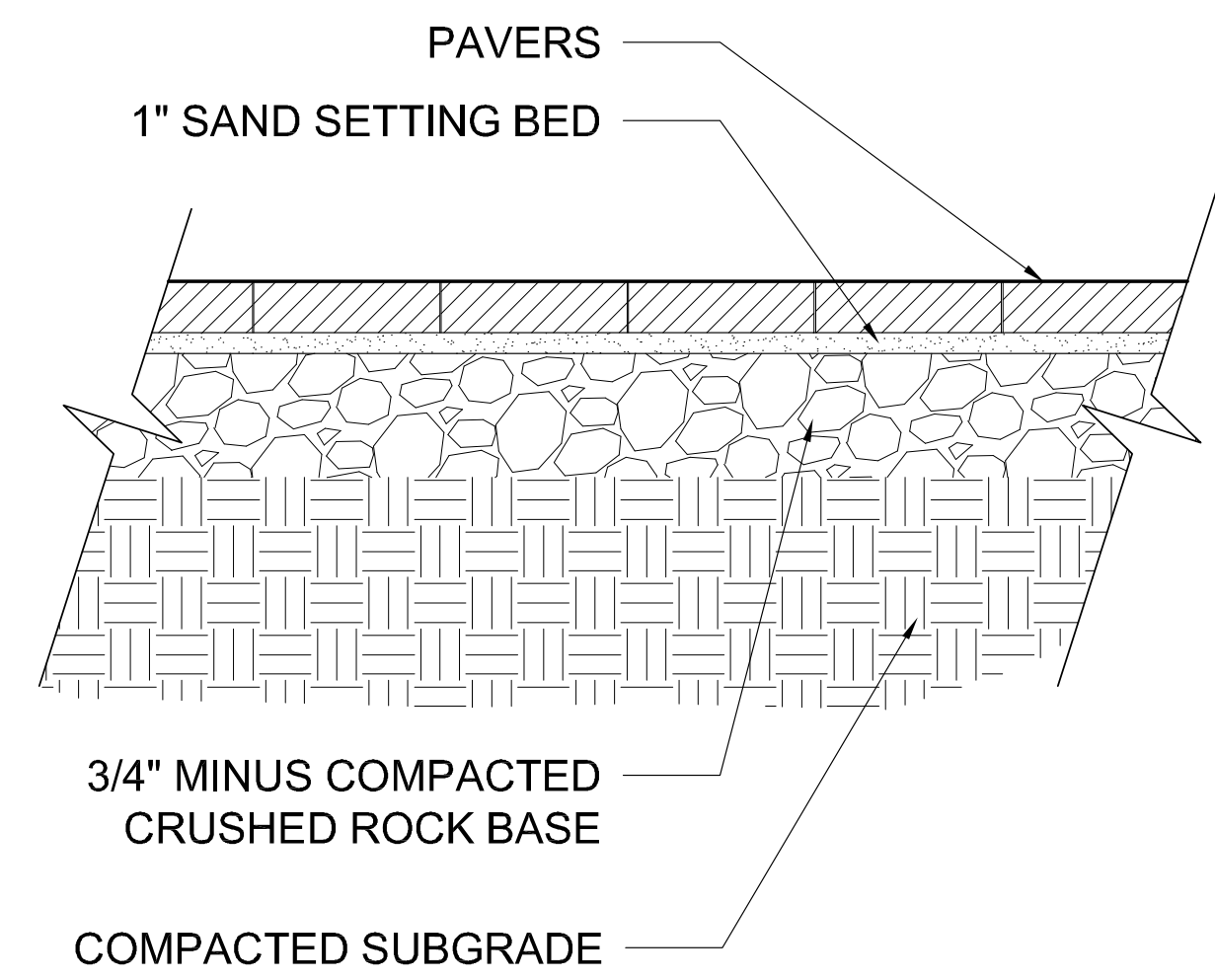

5 SAND SET PAVERS
 NTS

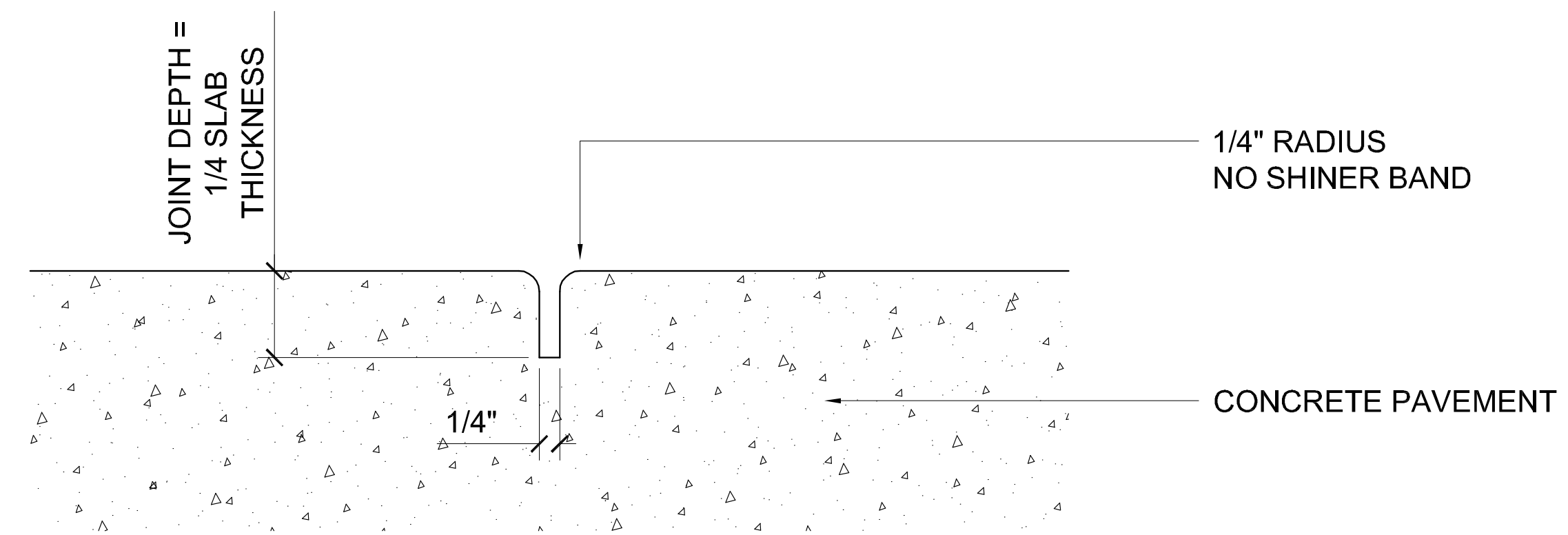

2 SCORE JOINT
 NTS

**Bid Set
 06/13/15**

EOU 8th Street
 Improvements Project
**Material Details
 One**

**Landscape Plans
 L-06**

PLACE
 735 NW 13th Ave.
 Portland, OR 97209

EO
 EASTERN OREGON
 UNIVERSITY

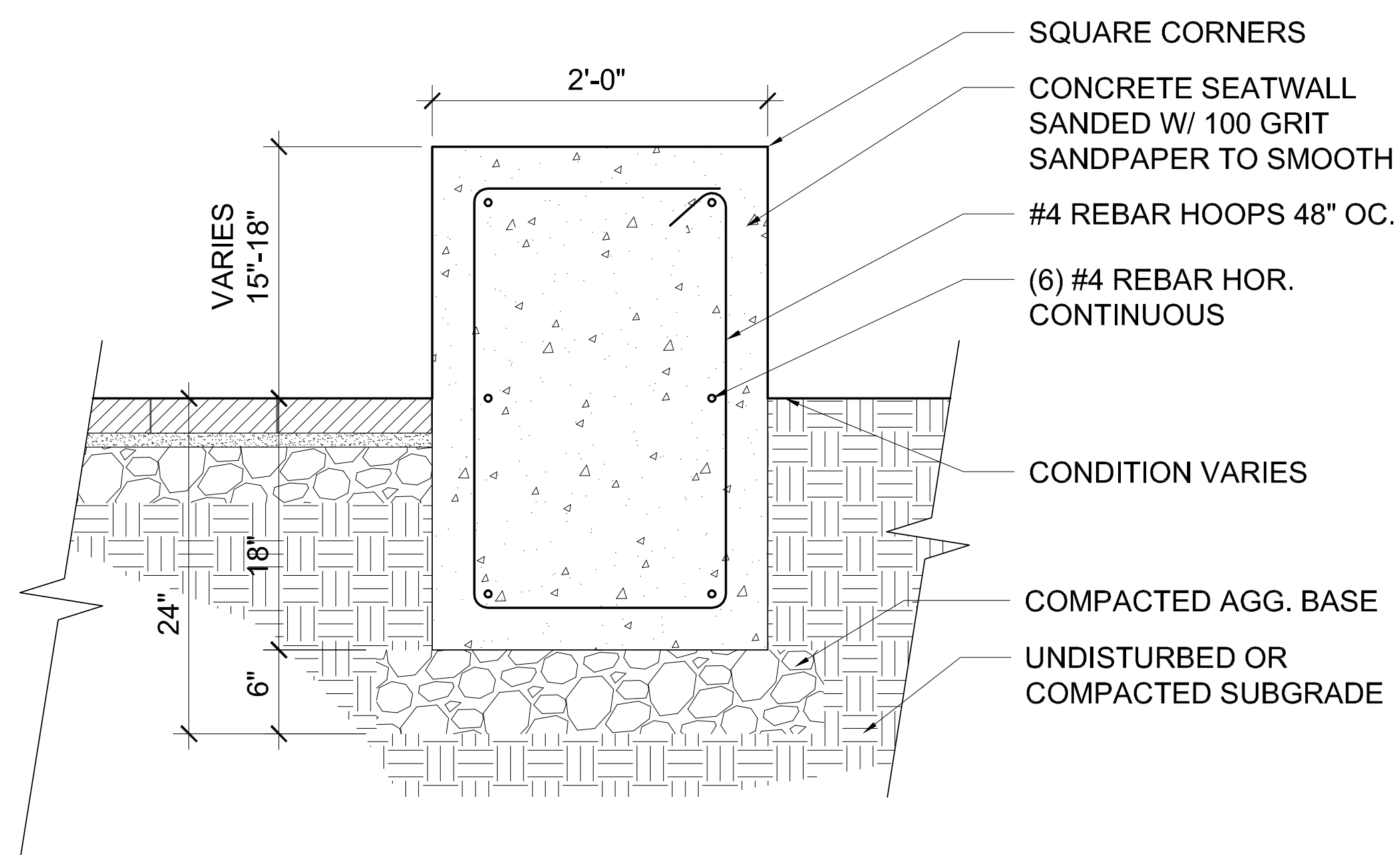

- SQUARE CORNERS
- CONCRETE SEATWALL
SANDED W/ 100 GRIT
SANDPAPER TO SMOOTH
- #4 REBAR HOOPS 48" OC.
- (6) #4 REBAR HOR.
CONTINUOUS
- CONDITION VARIES
- COMPACTED AGG. BASE
- UNDISTURBED OR
COMPACTED SUBGRADE

6

SEATWALL

NTS

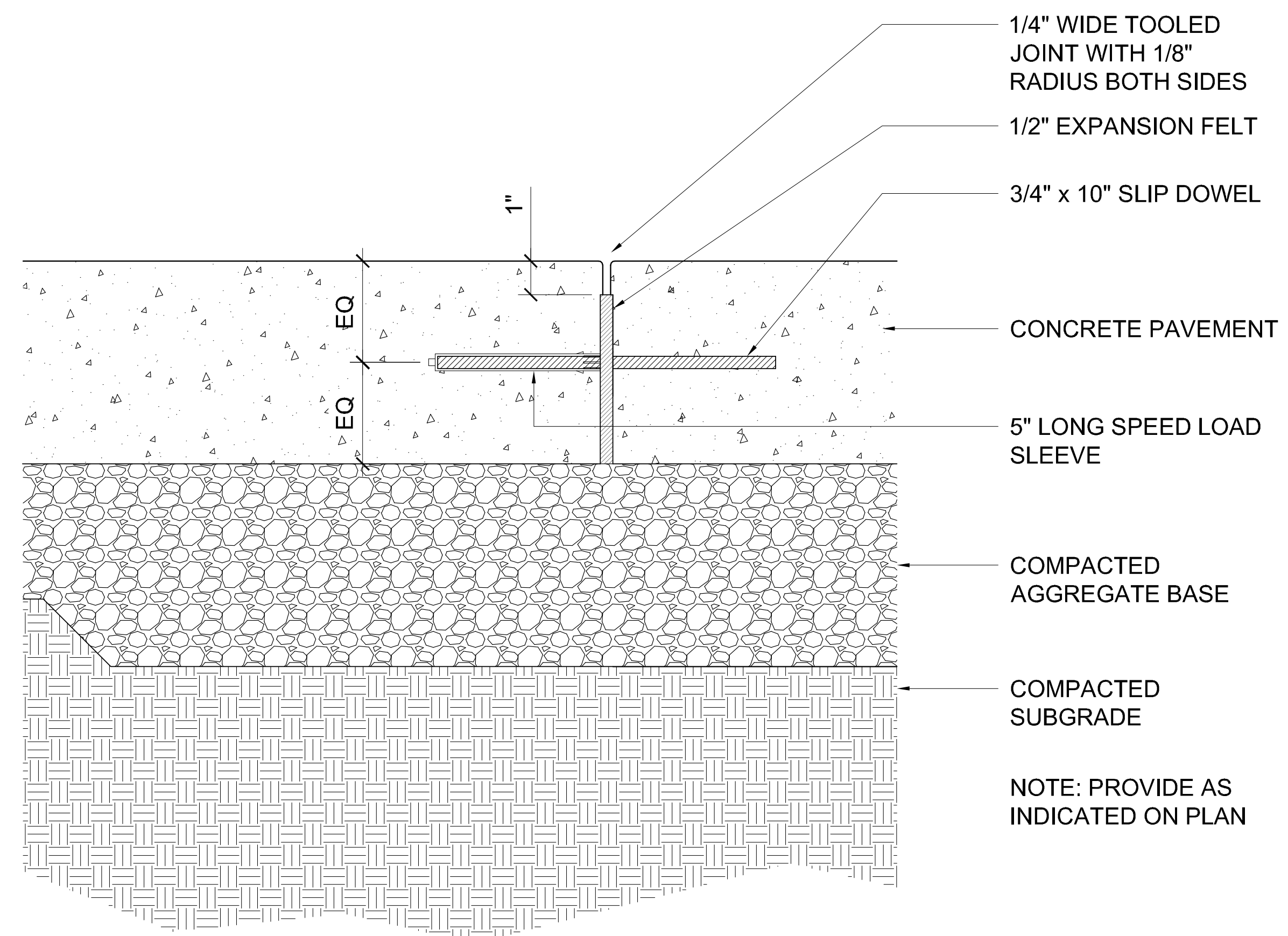

- 1/4" WIDE TOOLED
JOINT WITH 1/8"
RADIUS BOTH SIDES
- 1/2" EXPANSION FELT
- 3/4" x 10" SLIP DOWEL
- CONCRETE PAVEMENT
- 5" LONG SPEED LOAD
SLEEVE
- COMPACTED
AGGREGATE BASE
- COMPACTED
SUBGRADE
- NOTE: PROVIDE AS
INDICATED ON PLAN

3

ISOLATION JOINT AT CONCRETE PAVING

NTS

**Bid Set
06/13/15**

Improvements Project
Material Details
Two
Landscape Plans
L-07

PLACE
735 NW 18th Ave.
Portland, OR 97209

EO
EASTERN OREGON
UNIVERSITY