

ATTENTION BIDDERS

If you download this Invitation to Bid from this website, **it is your responsibility to advise WOU's Planning Office** that you have done so. This will allow us to add you to the Respondent's List, and advise you of any addenda issued for this project.

Failure to do so may cause your submittal to be rejected as non-responsive.

To add your company to the Respondent's List, simply email or fax a signed copy of your firm's letterhead to Donna Litchfield at:

litchfid@wou.edu

Or

Fax: 503 838-8081

Be sure to clearly identify the name and email address of a contact person within your firm.

OREGON UNIVERSITY SYSTEM

WESTERN OREGON UNIVERSITY

NOTICE OF PUBLIC IMPROVEMENT CONTRACT OPPORTUNITY

The Oregon University System (“OUS”) by and through on behalf of **Western Oregon University** (“Owner”) is accepting bids for a public improvement project at 345 N. Monmouth Ave., Monmouth, OR 97361, until **3:00 PM, February 25, 2015**, Pacific Time, for the **Hamersly Library Chiller Replacement** project located on the campus of **Western Oregon University**, in Monmouth, Oregon (“Project”).

A **mandatory pre-bid conference of the site and conditions** will be conducted on **Tuesday, February 17, 2015 at 10:00 AM**. Bidders shall meet with Owner’s Representative at the **Physical Plant Conference Room** for that purpose. Attendance will be documented through a sign-in sheet prepared by the Owner’s Representative. Prime bidders who arrive more than 10 minutes after start of time of the meeting (as stated in the solicitation and by the Owner’s Representative’s watch) or after the discussion portion of the meeting (whichever comes first) shall not be permitted to sign in and will not be permitted to submit a bid on the Project.

Bids will be opened and publicly read aloud on **Wednesday, February 25, 2015 at 3:00 PM**, at Physical Plant Office by the Owner’s representative or designee.

Bids will be received on a lump-sum basis for all of the work. **Bid packets may be obtained on the OUS Procurement Gateway website (<http://secure.ous.edu/bid/>).**

Prevailing Wage Rates requirements apply to this Project because the maximum compensation for all Owner-contracted Work is more than \$50,000. All bidders must comply with requirements of the prevailing wage law in ORS 279C.800 through ORS 279C.870. All bidders must be registered with the Construction Contractor’s Board at the time of bid submission. No bid will be considered unless fully completed in the manner provided in the “Instructions to Bidders” upon the Bid Form provided and accompanied by Bid Security.

Prevailing Wage Rates for Public Works Contracts in Oregon, January 1, 2015 which can be downloaded at the following web address: http://www.oregon.gov/boli/WHD/PWR/Pages/pwr_state.aspx The work will take place in Polk County.

Western Oregon University encourages bids from Minority, Women, and Emerging Small Businesses.

OREGON UNIVERSITY SYSTEM
STANDARD PUBLIC IMPROVEMENT CONTRACT
INSTRUCTIONS TO BIDDERS

Table of Contents

<u>Article</u>	<u>Title</u>
1.	Definitions
2.	Scope of Work
3.	Examination of Site and Conditions
4.	Substitute Materials Approval Process
5.	Interpretation of Project Manual
6.	Execution of the Bid Form
7.	Prohibition of Alterations to Bid
8.	Submission of Bid
9.	Bid Closing and Opening of Bids
10.	Acceptance or Rejection of Bids by Owner
11.	Withdrawal of Bid
12.	Execution of Contract, Agreement, Performance Bond and Payment Bond
13.	Recyclable Products
14.	Security to Be Furnished by Each Bidder
15.	Execution of Bid Bond

INSTRUCTIONS TO BIDDERS

Oregon Administrative Rules (“OAR”) Chapter 580, Divisions 61 and 63 govern this OUS procurement process.

Article 1. Definitions

1.1 Capitalized words used herein but not defined shall have the meaning set forth in the OUS Public Improvement General Conditions and OAR 580-061-0010. The following terms used herein shall have the meaning set forth below:

“**Bid Form**”- refers to OUS Contract Form B-5 provided by Owner to be completed by Bidder.

“**Project Manual**”- The Project Manual includes, but is not necessarily limited to the following: the Advertisement for Bids or Notice of Contracting Opportunity, these Instructions to Bidders, Supplemental Instructions to Bidders (if any), Bid Form, Bid Bond, Public Improvement Contract General Conditions, Supplemental General Conditions (if any), Sample Public Improvement Agreement Form, Performance Bond, Payment Bond, and the Plans and Specifications.

Article 2. Scope of Work

2.1 The Work contemplated in this document shall be for the Owner in connection with the Project described in the Project Manual.

Article 3. Examination of Site and Conditions

3.1 Before making a Bid, the Bidder shall examine the Work site to ascertain its physical condition. The Bidder shall be responsible for being fully informed as to the quality, quantity and sources of supply of the materials listed on the Project Manual. Failure to comply with this Section will not release Contractor from entering into the Contract or excuse Contractor from performing the Work in strict accordance with the terms of the Contract Documents.

3.2 The Owner will not be responsible for any loss or unanticipated costs which may arise as a result of Contractor's failure to be fully informed in advance with regard to all conditions pertaining to the Work and the character of the Work required.

3.3. No statement made by any officer, agent, or employee of the Owner in relation to the physical conditions pertaining to the Work site or quality, quantity, and supply of materials will be binding on the Owner, unless included in writing in the Project Manual or an Addendum.

Article 4. Substitute Materials Approval Process

4.1 Prior to submitting a Bid including a Substitution, the Bidder must first seek approval of the Substitution from the Architect (or Engineer, as appropriate hereafter) by submitting a written request for approval at least 10 calendar days prior to the Closing Date and Time. The Bidder submitting the request shall be responsible for its timely delivery.

4.2 Substitution approval requests shall be accompanied by samples, records of performance, certified copies of tests by impartial and recognized laboratories and such other information as the Architect may request.

4.3 Within a reasonable time after receiving such a request the Owner (or Architect if so designated) will consider whether the Substitution sought by Bidder is of equal value or utility as the designated product in the Project Manual. If the requested Substitution is approved an Addendum to the Project Manual shall be issued. A copy of each Addendum will be posted on the OUS Bid and Business Opportunities website (<http://secure.ous.edu/bid>) and shall become a part of the Project Manual.

4.4 When the Architect approves a Substitution by Addendum, it is with the understanding that the Contractor guarantees the substituted article or material to be equal or better than the one specified.

Article 5. Interpretation of Project Manual

5.1 A Bidder in doubt as to the meaning of any part of the Project Manual may submit a written request for an interpretation to the Architect at any time prior to 10 calendar days prior to the Closing Date and Time.

5.2 Any interpretation of the Project Manual will be made only by a duly issued Addendum. The Owner will not be responsible for any other explanation or interpretation of the Project Manual nor for any other approval of a particular manufacturer's process or item.

5.3 To establish a basis of quality, certain processes, types of machinery and equipment or kinds of materials may be specified in the Project Manual either by description of process or by designating a manufacturer by name and referring to a brand or product designation or by specifying a kind of material. Whenever a process is designated or a manufacturer named, brand or item designation given, or whenever a process or material covered by patent is designated or described, it shall be understood that the words "or approved equal" follow such name, designation or description, whether they do so or not.

Article 6. Execution of the Bid Form

6.1 The Bid Form relates to Bids on a specific Project Manual. Only the amounts and information asked for on the Bid Form furnished by the Owner will be considered as the Bid. Each Bidder shall Bid upon the Work exactly as set forth in the Bid Form. The Bidder shall include in the Bid a sum to cover the cost of all items contemplated by the Project Manual. Bids that fail to address alternates set forth on the Bid Form may be considered non-responsive.

6.2 Each Bid Form must: 1) Be completed in accordance with these instructions; 2) Include the appropriate signatures as noted on the Bid Form; 3) Include numbers pertaining to base Bids stated both in writing and in figures; and 4) Include the Bidder's typed or clearly printed address.

6.3 When bidding on an alternate for which there is no charge, the Bidder shall write the words "No Charge" in the space provided on the Bid Form. If one or more alternates are shown on the Bid Form, the Bidder shall indicate whether each is "add" or "deduct."

Article 7. Prohibition of Alterations to Bid

7.1 Bids which are incomplete, or contain ambiguities or conditions not provided for in the Bid Form, may be rejected.

Article 8. Submission of Bid

8.1 Each Bid shall be sealed in an envelope, properly addressed to the appropriate project representative of the Owner, showing on the outside of the envelope the name of the Bidder and the name of the project. Bids will be received at the time and place stated in the Advertisement for Bids.

Article 9. Bid Closing and Opening of Bids

9.1 All Bids must be received by the Owner before the Closing Date and Time. Any Bids received after the Closing Date and Time will be rejected and returned to the Bidder unopened.

9.2 At the time of opening and reading of Bids, each Bid received, irrespective of any irregularities or informalities will be publicly opened and read aloud.

Article 10. Acceptance or Rejection of Bids by Owner

10.1 Unless all Bids are rejected, the Owner will award the Contract based on the lowest responsive Bid from a responsible Bidder. If that Bidder does not execute the

Contract, the Contract will be awarded to the next lowest responsible Bidder or Bidders in succession.

10.2 The procedures for Contract awards shall be in compliance with the provisions of OARs adopted by the Owner.

10.3 The Owner reserves the right to reject all Bids and to waive minor informalities.

10.4 The Owner reserves the right to hold the Bid and any required Bid security, of the three lowest Bidders for a period of 30 calendar days from the time of Bid opening pending award of the Contract. Following award of the Contract, any Bid security furnished by the three lowest Bidders may be held 20 calendar days pending execution of the Contract. All other Bids will be rejected and Bid security returned.

10.5 In determining the lowest Bidder, the Owner reserves the right to take into consideration any or all authorized base Bids as well as alternates or combinations indicated in the Bid Form.

10.6 If Owner has not accepted a Bid within 30 calendar days after the opening of the Bids, each of the three lowest Bidders may withdraw the Bid submitted and request the return of any Bid security then held.

Article 11. Withdrawal of Bid

11.1 At any time prior to the Closing Date and Time a Bidder may withdraw its Bid. This will not preclude the submission of another Bid by such Bidder prior to the Closing Date and Time.

11.2 After the Closing Date and Time, no Bidder will be permitted to withdraw its Bid within the time period specified in Article 10 for award and execution, except as provided for in that Article.

Article 12. Execution of Contract, Agreement, Performance Bond and Payment Bond

12.1 The Owner will provide the successful Bidder with Contract Documents within 10 calendar days after the award of the Contract. The Bidder shall be required to execute the Contract as provided, including a Performance Bond and a Payment Bond from a surety company licensed to do surety business in the State of Oregon, within 20 calendar days after the award of the Contract. The Contract Documents shall be delivered to the Owner in the manner stated in the Notice of Award.

Article 13. Recyclable Products

13.1 Contractors must use recyclable products to the

maximum extent economically feasible in the performance of the Contract.

Article 14. Security to Be Furnished by Each Bidder

14.1 Each Bid must be accompanied by either: 1) a cashier's check or a certified check drawn on a bank authorized to do business in the State of Oregon, or 2) a Bid Bond described hereinafter, executed in favor of Owner, for an amount equal to 10 percent of the total Bid amount as a guarantee that if awarded the contract the Bidder will execute the contract and give a Performance Bond and Payment Bond as required.

14.2 The Contractor's check or Bid Bond will be retained until the Contractor has entered into a Contract and furnished a 100 percent Performance Bond and 100 percent Payment Bond.

14.3 The Owner reserves the right to hold the Bid security as described in Article 10. Should the successful Bidder fail to execute and deliver the Contract as provided for in Article 12, including a satisfactory performance bond and payment bond within 20 calendar days after the Bid has been accepted by the Owner, then the Contract award may be canceled and the Bid security may be forfeited as liquidated damages, at the option of the Owner. The date of the acceptance of the Bid and the award of the contract as contemplated by the Project Manual shall mean the date of acceptance specified in the Notice of Award.

Article 15. Execution of Bid Bond

15.1 Should the Bidder elect to utilize a Bid Bond as described in Article 14 in order to satisfy the Bid security requirements, such form must be completed in the following manner:

15.1.1 Bid Bonds must be executed on OUS forms, which will be provided to all prospective Bidders by the Owner.

15.1.2 The Bid Bond shall be executed on behalf of a bonding company licensed to do business in the State of Oregon.

15.1.3 In the case of a sole individual, the Bid Bond need only be executed as principal by the sole individual. In the case of a partnership, the Bid Bond must be executed by at least one of the partners. In the case of a corporation, the Bid Bond must be executed by stating the official name of the corporation under which is placed the signature of an officer authorized to sign on behalf of the corporation followed by such person's official capacity, such as president, etc. This signature shall be attested by the secretary or assistant secretary of the corporation. The

corporation seal should then be affixed to the Bid Bond. In the case of a limited liability company/corporation ("LLC"), the Bid Bond must be executed by stating the official name of the LLC under which is placed the signature of a member authorized to sign on behalf of the LLC.

15.1.4 The name of the surety must be stated in the execution over the signature of its duly authorized attorney-in-fact and accompanied by the seal of the surety corporation.

OREGON UNIVERSITY SYSTEM
STANDARD PUBLIC IMPROVEMENT CONTRACT
SUPPLEMENTAL INSTRUCTIONS TO BIDDERS

Project Name Hamersly Library Chiller Replacement

The following modify the Oregon University System “Instructions to Bidders, Form B-2” for this procurement. Where a portion of the Instructions to Bidders has been modified by these Supplemental Instructions to Bidders, the unaltered portions shall remain in effect.

Complete Bids (including all attachments) may be received electronically via email by the Closing Date and Time **Wednesday, February 25, 2015 at 3:00 PM Pacific Time.** **The Bid must be emailed to: bids@wou.edu, the email subject line must be “Bid for Hamersly Library Chiller Replacement.” Bidders submitting an electronic Bid will receive an automatic email reply.** Bidders that do not receive an automatic reply ***must*** telephone and confirm electronic receipt of the complete emailed document(s) before the Closing Date and Time. Bids delayed or lost by email system filtering or failures may be considered at Owner’s sole discretion.

In addition to electronic submission, the original copy of the Bid must be postmarked no later than 5 days . The envelope/package containing the Proposal must be clearly marked **“Bid for Hamersly Library Chiller Replacement.”**

OREGON UNIVERSITY SYSTEM
STANDARD PUBLIC IMPROVEMENT CONTRACT

BID BOND

Project Name: Hamersly Library Chiller Replacement

We, _____, as "Principal,"
(Name of Principal)

and _____, an _____ Corporation,
(Name of Surety)

authorized to transact Surety business in Oregon, as "Surety," hereby jointly and severally bind ourselves, our respective heirs, executors, administrators, successors and assigns to pay unto the State of Oregon and the Oregon State Board of Higher Education ("Obligee") the sum of (\$_____)

_____ dollars.

WHEREAS, the condition of the obligation of this bond is that Principal has submitted its proposal or bid to an agency of the Obligee in response to Obligee's procurement document (No. _____) for the project identified as:

_____ which proposal or bid is made a part of this bond by reference, and Principal is required to furnish bid security in an amount equal to ten (10%) percent of the total amount of the bid pursuant to the procurement document.

NOW, THEREFORE, if the proposal or bid submitted by Principal is accepted, and if a contract pursuant to the proposal or bid is awarded to Principal, and if Principal enters into and executes such contract within the time specified in the Instructions to Bidders and executes and delivers to Obligee its good and sufficient Performance Bond and Payment Bond required by Obligee within the time fixed by Obligee, then this obligation shall be void; otherwise, it shall remain in full force and effect.

IN WITNESS WHEREOF, we have caused this instrument to be executed and sealed by our duly authorized legal representatives this _____ day of _____, 20____.

PRINCIPAL: _____

SURETY: _____

By _____
Signature

BY ATTORNEY-IN-FACT:

Official Capacity

Name

Attest: _____
Corporation Secretary

Signature

Address

City State Zip

Phone Fax

OREGON UNIVERSITY SYSTEM
STANDARD PUBLIC IMPROVEMENT CONTRACT
BID FORM

OUS CAMPUS: **Western Oregon University**
PROJECT: **Hamersly Library Chiller Replacement**
BID CLOSING DATE: **Wednesday, February 25, 2015**
BID OPENING: **3:00 PM, Pacific Time**

FROM: _____
Name of Contractor

TO: Oregon State Board of Higher Education
 Western Oregon University
 Physical Plant Planning Office
 345 N. Monmouth, OR 97361

1. The Undersigned (*check one of the following and insert information as requested*):

____ a. An individual doing business under an assumed name registered under the laws of the State of _____; or

____ b. A partnership registered under the laws of the State of _____;

or

____ c. A corporation organized under the laws of the State of _____; or

____ d. A limited liability corporation/company organized under the laws of the State of _____;

hereby proposes to furnish all material and labor and perform all Work hereinafter indicated for the above project in strict accordance with the Contract Documents for the Basic Bid as follows:

_____ Dollars (\$_____),

and the Undersigned agrees to be bound by each of the following documents:

- Advertisement for Bids or Notice of Public Improvement Contracting Opportunity
- Instructions to Bidders
- Supplemental Instructions to Bidders, if any
- Bid Bond
- OUS Public Improvement General Conditions
- Supplemental General Conditions, if any

- Sample Public Improvement Agreement Form
- Performance Bond and Payment Bond
- Plans and Specifications
- Drawings and Details
- Prevailing Wage Rates
- Payroll and Certified Statement Form
- Any ADDENDA numbered ____ through ____, inclusive (*fill in blanks*).

2. The Undersigned proposes to deduct from the Base Bid indicated above the items of work relating to the following Alternate(s) as designated in the Specifications:

ALTERNATE #1: Cost of Demolition and Disposal of Chiller, Cooling Tower and associated equipment and all associated fees:

DEDUCT: \$ _____

4. The work shall be completed within the time stipulated and specified in Project Requirements

5. The Undersigned certifies that: (1) This Bid has been arrived at independently and is being submitted without collusion with and without any agreement, understanding, or planned common course of action with any other vendor of materials, supplies, equipment or services described in the invitation to bid designed to limit independent bidding or competition; and (2) The contents of the Bid have not been communicated by the Undersigned or its employees or agents to any person not an employee or agent of the Undersigned or its surety on any Bond furnished with the Bid and will not be communicated to such person prior to the official opening of the Bid.

6. The undersigned **HAS, HAS NOT** (*circle applicable status*) paid unemployment or income taxes in Oregon within the past 12 months and **HAS, HAS NOT** (*circle applicable status*) a business address in Oregon.

7. The Undersigned agrees, if awarded a contract, to comply with the provisions of ORS 279C.800 through 279C.870 pertaining to the payment of the prevailing rates of wage.

8. Contractor's CCB registration number is _____. As a condition to submitting a bid, a Contractor must be registered with the Oregon Construction Contractors Board in accordance with ORS 701.035 to 701.055, and disclose the registration number. Failure to register and disclose the number will render the bid unresponsive and it will be rejected, unless contrary to federal law.

9. The successful Bidder hereby certifies that all subcontractors who will perform construction work as described in ORS 701.005(2) were registered with the Construction Contractors Board in accordance with ORS 701.035 to 701.055 at the time the subcontractor(s) made a bid to work under the Contract.

10. The successful Bidder hereby certifies that, in compliance with the Worker's Compensation Law of the State of Oregon, its Worker's Compensation Insurance provider is _____, Policy No. _____, and that Contractor shall submit Certificates of Insurance as required.

11. Contractor's Project Manager for this project is: _____,
Office Phone: _____ Cell Phone: _____
Email Address: _____

12. The Undersigned certifies that it has not discriminated against minority, women, or emerging small businesses in obtaining any subcontracts for this project.

13. Accompanying herewith is Bid Security which is equal to ten (10) percent of the total amount of the Basic Bid.

14. The Undersigned further agrees that the Bid Security accompanying the Bid is left in escrow with the Board; that the amount thereof is the measure of liquidated damages which the Owner will sustain by the failure of the Undersigned to execute and deliver the above-named Agreement Form, Performance Bond and Payment Bond, and, that if the Undersigned defaults in either executing the Agreement Form or providing the Performance Bond and Payment Bond within twenty (20) calendar days after receiving the Contract Documents, then the Bid Security may become the property of the Owner at the Owner's option; but if the Bid is not accepted within thirty (30) calendar days of the time set for the opening of the Bids, or if the Undersigned executes and timely delivers said Agreement Form, Performance Bond and Payment Bond, the Bid Security shall be returned.

15. The Undersigned agrees, if awarded the Contract, to execute and deliver to Owner, within twenty (20) calendar days after receiving the Contract Documents, an Agreement Form and a satisfactory Performance Bond and Payment Bond, each in an amount equal to one hundred (100) percent of the Contract sum, using forms provided by the Owner. The surety requested to issue the Performance Bond and Payment Bond will be:

(name of surety company - not insurance agency)

The Undersigned hereby authorizes said surety company to disclose any information to the Owner concerning the Undersigned's ability to supply a Performance Bond and Payment Bond each in the amount of the Contract.

By signature below, Contractor agrees to be bound by this Bid.

NAME OF FIRM _____

ADDRESS _____

FEDERAL TAX ID _____

TELEPHONE NO _____

FAX NO _____

SIGNATURE 1) _____

Sole Individual

or 2) _____

Partner

or 3) _____

Authorized Officer of Corporation

(SEAL)

Attested: Secretary of Corporation

Payment information will be reported to the IRS under the name and taxpayer ID # provided above. Information not matching IRS records could subject Contractor to 31 percent backup withholding.

******* END OF BID *******

OREGON UNIVERSITY SYSTEM SAMPLE PUBLIC IMPROVEMENT CONTRACT

This Public Improvement Contract for the **Hamersly Library Chiller Replacement** (the "Contract"), made by and between the State of Oregon, acting by and through the Oregon State Board of Higher Education on behalf of **Western Oregon University**, hereinafter called OWNER, and **(Insert Contractor's Name)** hereinafter called the CONTRACTOR (collectively the "Parties"), shall become effective on **(Insert contract award date)**, or the date this Contract has been signed by all the Parties and all required State of Oregon governmental approvals have been obtained, whichever is later.

WITNESSETH:

1. Contract Price, Contract Documents and Work.

The CONTRACTOR, in consideration of the sum of _____ (the "Contract Price"), to be paid to the CONTRACTOR by OWNER in the manner and at the time hereinafter provided, and subject to the terms and conditions provided for in the Instructions to Bidders and other Contract Documents (as defined in the Oregon University System General Conditions For Public Improvement Contracts referenced within the Instructions to Bidders), all of which are incorporated herein by reference, hereby agrees to perform all Work described and reasonably inferred from the Contract Documents. The Contract Price is the amount contemplated by the Base Bid [*adjusted for Alternates* **Identify accepted Alternates**], as indicated in the accepted Bid.

Also, the following documents are incorporated by reference in this Contract and made a part hereof if checked for inclusion [X]:

<input type="checkbox"/>	Oregon University System General Conditions	<input type="checkbox"/>	Prevailing Wage Rates
<input type="checkbox"/>	Supplemental General Conditions	<input type="checkbox"/>	Payment and Performance Bond
<input type="checkbox"/>	Plans, Specifications	<input type="checkbox"/>	
<input type="checkbox"/>		<input type="checkbox"/>	

2. Representatives.

CONTRACTOR has named **(Insert Name)** its' Authorized Representative to act on its behalf. OWNER designates, or shall designate, its Authorized Representative as indicted below (check one):

A. Unless otherwise specified in the Contract Documents, the OWNER designates **Tony Kment** as its Authorized Representative in the administration of this Contract. The above-named individual shall be the initial point of contact for matters related to Contract performance, payment authorization, and to carry out the responsibilities of the OWNER.

B. Name of OWNER'S Authorized Representative shall be submitted by OWNER in a separate writing.

3. Key Persons.

CONTRACTOR's personnel indicated below are specifically valuable to the Project ("Key Persons"). Key Persons shall not be replaced during the project without the written consent of OWNER, which shall not be unreasonably withheld. If CONTRACTOR intends to substitute personnel, OWNER shall receive the request at least 15 days prior to the effective date of substitution. When replacements have been approved by OWNER, CONTRACTOR shall provide a transition period of at least 10 working days during which the original and replacement personnel shall be working on the project concurrently. Upon authorization for the replacement of a Key Person, all subsequent substitutions of that Key Person shall require OWNER's written consent in accordance with this Section. The Key Persons for this Project are the following:

Project Executive: _____ shall be CONTRACTOR's Project Executive, and will provide oversight and guidance throughout the Project term.

Project Manager: _____ shall be CONTRACTOR's Project Manager and will participate in all meetings throughout the Project term.

Job Superintendent: _____ shall be CONTRACTOR's on-site Job Superintendent throughout the Project term.

Project Engineer: _____ shall be CONTRACTOR's Project Engineer, providing assistance to the Project Manager, and subcontractor and supplier coordination throughout the Project term.

4. Contract Dates.

COMMENCEMENT DATE: **Notice to Proceed**

SUBSTANTIAL COMPLETION DATE: **May 1, 2015**

FINAL COMPLETION DATE: **May 15, 2015**

5. Tax Compliance.

The individual signing on behalf of CONTRACTOR hereby affirms, under penalty of perjury as provided in ORS 305.385(6), that, to the best of CONTRACTOR's knowledge, the CONTRACTOR is not in violation of any of the tax laws described in ORS 305.380(4). For purposes of this certification, "tax laws" means a state tax imposed by ORS 320.005 to 320.150 and 403.200 to 403.250, ORS Chapters 118, 314, 316, 317, 318, 321 and 323; the elderly rental assistance program under ORS 310.630 to 310.706; and local taxes administered by the Oregon Department of Revenue under ORS 305.620.

6. Integration

The Contract documents constitute the entire agreement between the parties. There are no other understandings, agreements or representations, oral or written, not specified herein regarding this Contract. CONTRACTOR, by the signature below of its authorized representative, hereby

acknowledges that it has read this Contract, understands it, and agrees to be bound by its terms and conditions.

In witness whereof, the State of Oregon, acting by and through the Oregon State Board of Higher Education on behalf of **Western Oregon University** executes this Contract and the CONTRACTOR does execute the same as of the day and year indicated below.

CONTRACTOR DATA:

(Insert Contractor Name & Address)

CONTRACTOR NAME _____
CONTRACTOR FEDERAL TAX ID # _____
CONTRACTOR CCB # _____ Expiration Date: _____

[Payment information will be reported to the IRS under the name and taxpayer ID # provided above. Information must be provided prior to contract approval. Information not matching IRS records could subject Contractor to 31 percent backup withholding.]

CONTRACTOR SIGNATURE

By _____
Signature Date

Print Name Title

STATE OF OREGON acting by and through the
OREGON STATE BOARD OF HIGHER EDUCATION
on behalf of Western Oregon University

By _____
Name/Title Date

By _____
Name/Title Date

OREGON UNIVERSITY SYSTEM
SUPPLEMENTAL GENERAL CONDITIONS

To The

GENERAL CONDITIONS
FOR PUBLIC IMPROVEMENT CONTRACTS

Project Name Hamersly Library Chiller Replacement

The following modify the July 2012 Oregon University System General Conditions for Public Improvement Contracts (“OUS Public Improvement General Conditions”) for this Contract. Where a portion of the OUS Public Improvement General Conditions is modified by these Supplemental General Conditions, the unaltered portions shall remain in effect.

None at time of bid posting

OREGON UNIVERSITY SYSTEM

GENERAL CONDITIONS FOR PUBLIC IMPROVEMENT CONTRACTS

July 1, 2012

INSTRUCTIONS: The attached **Oregon University System General Conditions for Public Improvement Contracts** ("OUS Public Improvement General Conditions") apply to all designated public improvement contracts. Changes to the OUS Public Improvement General Conditions (including any additions, deletions or substitutions) should only be made by attaching Public Improvement Supplemental General Conditions. The text of these OUS Public Improvement General Conditions should not otherwise be altered.

TABLE OF SECTIONS

SECTION A **GENERAL PROVISIONS**

- A.1 DEFINITION OF TERMS
- A.2 SCOPE OF WORK
- A.3 INTERPRETATION OF CONTRACT DOCUMENTS
- A.4 EXAMINATION OF PLANS, SPECIFICATIONS, AND SITE
- A.5 INDEPENDENT CONTRACTOR STATUS
- A.6 RETIREMENT SYSTEM STATUS AND TAXES
- A.7 GOVERNMENT EMPLOYMENT STATUS

SECTION B **ADMINISTRATION OF THE CONTRACT**

- B.1 OWNER'S ADMINISTRATION OF THE CONTRACT
- B.2 CONTRACTOR'S MEANS AND METHODS
- B.3 MATERIALS AND WORKMANSHIP
- B.4 PERMITS
- B.5 COMPLIANCE WITH GOVERNMENT REGULATIONS
- B.6 SUPERINTENDENCE
- B.7 INSPECTION
- B.8 SEVERABILITY
- B.9 ACCESS TO RECORDS
- B.10 WAIVER
- B.11 SUBCONTRACTS AND ASSIGNMENT
- B.12 SUCCESSORS IN INTEREST
- B.13 OWNER'S RIGHT TO DO WORK
- B.14 OTHER CONTRACTS
- B.15 GOVERNING LAW
- B.16 LITIGATION
- B.17 ALLOWANCES
- B.18 SUBMITTALS, SHOP DRAWINGS, PRODUCT DATA, AND SAMPLES
- B.19 SUBSTITUTIONS
- B.20 USE OF PLANS AND SPECIFICATIONS
- B.21 FUNDS AVAILABLE AND AUTHORIZED
- B.22 NO THIRD PARTY BENEFICIARIES

SECTION C **WAGES AND LABOR**

- C.1 MINIMUM WAGES RATES ON PUBLIC WORKS
- C.2 PAYROLL CERTIFICATION AND FEE REQUIREMENTS, ADDITIONAL RETAINAGE
- C.3 PROMPT PAYMENT AND CONTRACT CONDITIONS
- C.4 PAYMENT FOR MEDICAL CARE
- C.5 HOURS OF LABOR

SECTION D **CHANGES IN THE WORK**

- D.1 CHANGES IN THE WORK
- D.2 DELAYS
- D.3 CLAIMS REVIEW PROCESS

SECTION E
PAYMENTS

- E.1 SCHEDULE OF VALUES
- E.2 APPLICATIONS FOR PAYMENT
- E.3 PAYROLL CERTIFICATION REQUIREMENT
- E.4 DUAL PAYMENT SOURCES
- E.5 RETAINAGE
- E.6 FINAL PAYMENT

SECTION F
JOB SITE CONDITIONS

- F.1 USE OF PREMISES
- F.2 PROTECTION OF WORKERS, PROPERTY, AND THE PUBLIC
- F.3 CUTTING AND PATCHING
- F.4 CLEANING UP
- F.5 ENVIRONMENTAL CONTAMINATION
- F.6 ENVIRONMENTAL CLEAN-UP
- F.7 FORCE MAJEURE

SECTION G
INDEMNITY, BONDING AND INSURANCE

- G.1 RESPONSIBILITY FOR DAMAGES/INDEMNITY
- G.2 PERFORMANCE AND PAYMENT SECURITY, PUBLIC WORKS BOND
- G.3 INSURANCE

SECTION H
SCHEDULE OF WORK

- H.1 CONTRACT PERIOD
- H.2 SCHEDULE
- H.3 PARTIAL OCCUPANCY OR USE

SECTION I
CORRECTION OF WORK

- I.1 CORRECTIONS OF WORK BEFORE FINAL PAYMENT
- I.2 WARRANTY WORK

SECTION J
SUSPENSION AND/OR TERMINATION OF THE WORK

- J.1 OWNER'S RIGHT TO SUSPEND THE WORK
- J.2 CONTRACTOR'S RESPONSIBILITIES
- J.3 COMPENSATION FOR SUSPENSION
- J.4 OWNER'S RIGHT TO TERMINATE CONTRACT
- J.5 TERMINATION FOR CONVENIENCE
- J.6 ACTION UPON TERMINATION

SECTION K
CONTRACT CLOSE-OUT

- K.1 RECORD DOCUMENTS
- K.2 OPERATION AND MAINTENANCE MANUALS
- K.3 COMPLETION NOTICES
- K.4 TRAINING
- K.5 EXTRA MATERIALS
- K.6 ENVIRONMENTAL CLEAN-UP
- K.7 CERTIFICATE OF OCCUPANCY
- K.8 OTHER CONTRACTOR RESPONSIBILITIES
- K.9 SURVIVAL

**OREGON UNIVERSITY SYSTEM
GENERAL CONDITIONS FOR PUBLIC IMPROVEMENT CONTRACTS
("OUS Public Improvement General Conditions")**

**SECTION A
GENERAL PROVISIONS**

A.1 DEFINITION OF TERMS

In the Contract Documents the following terms shall be as defined below:

APPLICABLE LAWS, means federal, state and local laws, codes, rules, regulations and ordinances applicable to the Work and to the Contract.

ARCHITECT/ENGINEER, means the Person appointed by the Owner to make drawings and specifications and, to provide contract administration of the Work contemplated by the Contract to the extent provided herein or by supplemental instruction of Owner (under which Owner may delegate responsibilities to the Architect/Engineer), in accordance with ORS Chapter 671 (Architects) or ORS Chapter 672 (Engineers) and administrative rules adopted thereunder.

BID, means an offer binding on the Bidder and submitted in response to an Instructions to Bidders or a proposal in connection with a Request for Proposals.

BIDDER, means an Entity that submits a Bid in response to Instructions to Bidders or a proposer in connection with a Request for Proposals.

CHANGE ORDER, means a written order which, when fully executed by the Parties to this Contract, constitutes a change to the Contract Documents. Change Orders shall be issued in accordance with the changes provisions in Section D and, if applicable, establish a Contract Price or Contract Time adjustment. A Change Order shall not be effective until executed as a Change Order.

CLAIM, means a demand by Contractor pursuant to Section D.3 for review of the denial of Contractor's initial request for an adjustment of Contract terms, payment of money, extension of Contract Time or other relief, submitted in accordance with the requirements and within the time limits established for review of Claims in these OUS Public Improvement General Conditions.

CONSTRUCTION CHANGE DIRECTIVE, means a written order by the Owner to the Contractor requiring a change in the Work within the general scope of the Contract Documents, issued under the changes provisions of Section D.

CONTRACT, means the written agreement between the Owner and the Contractor comprised of the Contract Documents which describe the Work to be done and the obligations between the parties.

CONTRACT DOCUMENTS, means the Solicitation Document and addenda thereto, Instructions to Bidders, Supplemental Instructions to Bidders, the OUS Public Improvement Contract, OUS Public Improvement General Conditions, Public Improvement Supplemental General Conditions, if any, the accepted Bid, Plans, Specifications, Change Orders, and Construction Change Directives.

CONTRACT PERIOD, as set forth in the Contract Documents, means the total period of time beginning with the full execution of this Contract and, if applicable, the issuance of a Notice to Proceed and concluding upon Final Completion.

CONTRACT PRICE, means the total of the awarded Bid amount, as increased or decreased by the price of approved alternates, as indicated in the Contract Documents.

CONTRACT TIME, means any incremental period of time allowed

under the Contract to complete any portion of the Work as reflected in the project schedule.

CONTRACTOR, means the Person awarded the Contract for the Work contemplated.

DAYS, are calendar days, including weekdays, weekends and holidays, unless otherwise specified.

DIRECT COSTS, means, unless otherwise provided in the Contract Documents, the cost of materials, including sales tax, cost of delivery; cost of labor, including social security, Medicare and unemployment insurance, and fringe benefits required by agreement or custom; worker's compensation insurance; project specific insurance (including, without limitation, Builder's Risk Insurance and Builder's Risk Installation Floater); bond premiums, rental cost of equipment, and machinery required for execution of the Work; Owner's costs to correct defective Work; and the additional costs of field personnel directly attributable to the Work.

FINAL COMPLETION, means the final completion of all requirements under the Contract, including Contract Closeout as described in Section K but excluding Warranty Work as described in Section I.2, and the final payment and release of all retainage, if any, released.

FORCE MAJEURE, means an act, event or occurrence caused by fire, riot, war, acts of God, nature, sovereign, or public enemy, strikes, freight embargoes or any other act, event or occurrence that is beyond the control of the party to this Contract who is asserting Force Majeure.

MWESB REPORT, means an accurate report by the Contractor to the Owner identifying all Minority, Women and Emerging Small Business (MWESB) enterprises, as those terms are defined in ORS 200.005, receiving contracts throughout the course of the Work. An initial MWESB report is required (see Section E.2.9) and MWESB Reports are required annually (see Section E.2.9) and as a condition of final payment (see Section K.1). The initial report shall be in the form required by OUS and as posted from time to time on the OUS website and shall include the total number of contracts and subcontracts awarded to MWESB enterprises and the dollar value of their respective contracts and subcontracts. The annual reports shall include the total number of contracts and subcontracts awarded to MWESB enterprises, the dollar value of each, and the expenditure toward each contract and subcontract during the previous twelve (12) months. The final report shall include the total number of contracts and subcontracts awarded to MWESB enterprises and the dollar value of their respective contracts and subcontracts including all Change Orders incorporated during the course of the project. The reports shall only include enterprises certified with the State of Oregon as MWESB enterprises and shall include individual identification of each enterprise as a Minority business enterprise, a Women business enterprise, and/or an Emerging Small Business Enterprise, as applicable.

NOTICE TO PROCEED, means the official written notice from the Owner stating that the Contractor is to proceed with the Work defined in the Contract Documents. Notwithstanding the Notice to Proceed, Contractor shall not be authorized to proceed with the Work until all initial Contract requirements, including the Contract, performance bond and payment bond, and certificates of insurance, have been fully executed and submitted to Owner in a suitable form.

OVERHEAD, means those items which may be included in the Contractor's markup (general and administrative expense and profit) and that shall not be charged as Direct Cost of the Work,

including without limitation such Overhead expenses as wages or salary of personnel above the level of foreman (i.e., superintendents and project managers), expenses of Contractor's offices and supplies at the job site (e.g. job trailer) and at Contractor's principal place of business and including expenses of personnel staffing the job site office and Contractor's principal place of business, and Commercial General Liability Insurance and Automobile Liability Insurance.

OWNER, means the State of Oregon acting by and through the Oregon State Board of Higher Education, in its own right or on behalf of one of its institutions as identified in the Solicitation Document, also known as the Oregon University System (OUS). Owner may elect, by written notice to Contractor, to delegate certain duties to more than one party, including without limitation, to an Architect/Engineer. However, nothing in these OUS Public Improvement General Conditions is intended to abrogate the separate design professional responsibilities of Architects under ORS Chapter 671 or of Engineers under ORS Chapter 672.

PERSON, means a natural person or entity doing business as a sole proprietorship, a partnership, a joint venture, a corporation, a limited liability company or partnership, or any other entity possessing the legal capacity to contract.

PLANS, means the drawings which show the location, type, dimensions, and details of the Work to be done under the Contract.

PUNCH LIST, means the list of Work yet to be completed or deficiencies which need to be corrected in order to achieve Final Completion of the Contract.

RECORD DOCUMENT, means the as-built Plans, Specifications, testing and inspection records, product data, samples, manufacturer and distributor/supplier warranties evidencing transfer of ownership to Owner, operational and maintenance manuals, shop drawings, Construction Change Directives, MWESB Reports, correspondence, certificate(s) of occupancy, and other documents listed in Subsection B.9.1 of these OUS Public Improvement General Conditions, recording all Services performed.

SOLICITATION DOCUMENT, means Instructions to Bidders or Bidders or a Request for Proposal or a Request for Quotes.

SPECIFICATION, means any description of the physical or functional characteristics of the Work, or of the nature of a supply, service or construction item. Specifications may include a description of any requirement for inspecting, testing or preparing a supply, service or construction item for delivery and the quantities or qualities of materials to be furnished under the Contract. Specifications generally will state the results or products to be obtained and may, on occasion, describe the method and manner of doing the Work to be performed. Specifications may be incorporated by reference and/or may be attached to the Contract.

SUBCONTRACTOR, means a Person having a direct contract with the Contractor, or another Subcontractor, to perform one or more items of the Work.

SUBSTANTIAL COMPLETION, means the date when the Owner accepts in writing the construction, alteration or repair of the improvement to real property constituting the Work or any designated portion thereof as having reached that state of completion when it may be used or occupied for its intended purpose. Substantial Completion of facilities with operating systems occurs only after thirty (30) continuous Days of successful, trouble-free operation of the operating systems as provided in Section K.4.2.

SUBSTITUTIONS, means items that in function, performance, reliability, quality, and general configuration are the same or better than the product(s) specified. Approval of any substitute item shall be solely determined by the Owner. The decision of the Owner is final.

PUBLIC IMPROVEMENT SUPPLEMENTAL GENERAL CONDITIONS, means those conditions that remove from, add to, or modify these OUS Public Improvement General Conditions. Public Improvement Supplemental General Conditions may be included in the Solicitation Document or may be a separate attachment to the Contract.

WORK, means the furnishing of all materials, equipment, labor, transportation, services and incidentals necessary to successfully complete any individual item or the entire Contract and the carrying out of duties and obligations imposed by the Contract Documents.

A.2 SCOPE OF WORK

The Work contemplated under this Contract includes all labor, materials, transportation, equipment and services for, and incidental to, the completion of all construction work in connection with the project described in the Contract Documents. The Contractor shall perform all Work necessary so that the project can be legally occupied and fully used for the intended use as set forth in the Contract Documents.

A.3 INTERPRETATION OF CONTRACT DOCUMENTS

- A.3.1 Unless otherwise specifically defined in the Contract Documents, words which have well-known technical meanings or construction industry meanings are used in the Contract Documents in accordance with such recognized meanings. Contract Documents are intended to be complementary. Whatever is called for in one, is interpreted to be called for in all. However, in the event of conflicts or discrepancies among the Contract Documents, interpretations will be based on the following descending order of precedence:
- (a) Contract Change Orders and Construction Change Directives, with those of later date having precedence over those of an earlier date;
 - (b) The Public Improvement Supplemental General Conditions;
 - (c) The OUS Public Improvement Contract;
 - (d) The OUS Public Improvement General Conditions;
 - (e) Division One (General Requirements) of the Specifications;
 - (f) Detailed Schedules of finishes, equipment and other items included in the Specifications;
 - (g) Plans and Specifications (other than Division One and the Detailed Schedules to the Specifications);
 - (h) Large-scale drawings on Plans;
 - (i) Small-scale drawings on Plans;
 - (j) Dimension numbers written on Plans which shall prevail and take precedence over dimensions scaled from Plans;
 - (k) The Solicitation Document, and any addenda thereto;
 - (l) The accepted Bid.
- A.3.2 In the case of an inconsistency between Plans and Specifications or within either document not clarified by addendum, the better quality or greater quantity of Work shall be provided in accordance with the Owner's interpretation in writing.
- A.3.3 If the Contractor finds discrepancies in, or omissions from the Contract Documents, or if the Contractor is in doubt as to their meaning, the Contractor shall at once notify the Owner. Matters concerning and interpretation of requirements of the Contract Documents will be decided by the Owner, who may delegate that duty in some instances to the Architect/Engineer. Responses to Contractor's requests for interpretation of Contract

Documents will be made in writing by Owner (or the Architect/Engineer) within any time limits agreed upon or otherwise with reasonable promptness. Interpretations and decisions of the Owner (or Architect/Engineer) will be consistent with the intent of and reasonably inferable from the Contract Documents. Contractor shall not proceed without direction in writing from the Owner (or Architect/Engineer).

- A.3.4 References to standard specifications, manuals, codes of any technical society, organization or association, to the laws or regulations of any governmental authority, whether such reference be specific or by implication, shall mean the latest standard specification, manual, code, laws or regulations in effect in the jurisdiction where the project is occurring on the first published date of the Solicitation Document, except as may be otherwise specifically stated.

A.4 EXAMINATION OF PLANS, SPECIFICATIONS, AND SITE

- A.4.1 It is understood that the Contractor, before submitting a Bid, has made a careful examination of the Contract Documents; has become fully informed as to the quality and quantity of materials and the character of the Work required; and has made a careful examination of the location and conditions of the Work and the sources of supply for materials. The Owner will in no case be responsible for any loss or for any unanticipated costs that may be suffered by the Contractor as a result of the Contractor's failure to acquire full information in advance in regard to all conditions pertaining to the Work. No oral agreement or conversation with any officer, agent, or personnel of the Owner, or with the Architect/Engineer either before or after the execution of this Contract, shall affect or modify any of the terms or obligations herein contained.
- A.4.2 Should the Plans or Specifications fail to particularly describe the materials, kind of goods, or details of construction of any aspect of the Work, Contractor shall have the duty to make inquiry of the Owner and Architect/Engineer as to what is required prior to performance of the Work. Absent Specifications to the contrary, the materials or processes that would normally be used to produce first quality finished Work shall be considered a part of the Contract requirements.
- A.4.3 Any design errors or omissions noted by the Contractor shall be reported promptly to the Owner, including without limitation, any nonconformity with Applicable Laws.
- A.4.4 If the Contractor believes that adjustments to cost or Contract Time is involved because of clarifications or instructions issued by the Owner (or Architect/Engineer) in response to the Contractor's notices or requests for information, the Contractor must submit a written request to the Owner, setting forth the nature and specific extent of the request, including all time and cost impacts against the Contract as soon as possible, but no later than thirty (30) Days after receipt by Contractor of the clarifications or instructions issued. If the Owner denies Contractor's request for additional compensation, additional Contract Time, or other relief that Contractor believes results from the clarifications or instructions, the Contractor may proceed to file a Claim under Section D.3, Claims Review Process. If the Contractor fails to perform the obligations of Sections A.4.1 to A.4.3, the Contractor shall pay such costs and damages to the Owner as would have been avoided if the Contractor had performed such obligations.

A.5 INDEPENDENT CONTRACTOR STATUS

The service or services to be performed under this Contract are those of an independent contractor as defined in ORS 670.600. Contractor represents and warrants that it is not an officer, employee or agent of the Owner as those terms are used in ORS 30.265.

A.6 RETIREMENT SYSTEM STATUS AND TAXES

Contractor represents and warrants that it is not a contributing member of the Public Employees' Retirement System and will be responsible for any federal or state taxes applicable to payment received under this Contract. Contractor will not be eligible for any benefits from these Contract payments of federal Social Security, employment insurance, workers' compensation or the Public Employees' Retirement System, except as a self-employed individual. Unless the Contractor is subject to backup withholding, Owner will not withhold from such payments any amount(s) to cover Contractor's federal or state tax obligations.

A.7 GOVERNMENT EMPLOYMENT STATUS

- A.7.1 If this payment is to be charged against federal funds, Contractor represents and warrants that it is not currently employed by the Federal Government. This does not preclude the Contractor from holding another contract with the Federal Government.
- A.7.2 Contractor represents and warrants that Contractor is not an employee of the State of Oregon for purposes of performing Work under this Contract.

SECTION B ADMINISTRATION OF THE CONTRACT

B.1 OWNER'S ADMINISTRATION OF THE CONTRACT

- B.1.1 The Owner shall administer the Contract as described in the Contract Documents (1) during construction (2) until final payment is due and (3) during the one-year period for correction of Work. The Owner will act as provided in the Contract Documents, unless modified in writing in accordance with other provisions of the Contract. In performing these tasks, the Owner may rely on the Architect/Engineer or other consultants to perform some or all of these tasks.
- B.1.2 The Owner will visit the site at intervals appropriate to the stage of the Contractor's operations (1) to become generally familiar with and to keep the Owner informed about the progress and quality of the portion of the Work completed, (2) to endeavor to guard the Owner against defects and deficiencies in the Work, and (3) to determine in general if Work is being performed in a manner indicating that the Work, when fully completed, will be in accordance with the Contract Documents. The Owner will not make exhaustive or continuous on-site inspections to check the quality or quantity of the Work. The Owner will neither have control over or charge of, nor be responsible for the construction means, methods, techniques, sequences or procedures, or for the safety precautions and programs in connection with the Work.
- B.1.3 Except as otherwise provided in the Contract Documents or when direct communications have been specifically authorized, the Owner and Contractor shall communicate with each other about matters arising out of or relating to the Contract. Communications by and with the Architect/Engineer's consultants shall be through the Architect/Engineer. Communications by and with Subcontractors and material suppliers shall be through the Contractor. Communications by and with separate contractors shall be through the Owner.
- B.1.4 Based upon the Architect/Engineer's evaluations of the Contractor's Application for Payment, or unless otherwise stipulated by the Owner, the Architect/Engineer will review and certify the amounts due the Contractor and will issue Certificates for Payment in such amounts.

B.2 CONTRACTOR'S MEANS AND METHODS; MITIGATION OF IMPACTS

B.2.1 The Contractor shall supervise and direct the Work, using the Contractor's best skill and attention. The Contractor shall be solely responsible for and have control over construction means, methods, techniques, sequences and procedures and for coordinating all portions of the Work under the Contract, unless the Contract Documents give other specific instructions concerning these matters. If the Contract Documents give specific instructions concerning construction means, methods, techniques, sequences or procedures, the Contractor shall evaluate the jobsite safety thereof and, except as stated below, shall be fully and solely responsible for the jobsite safety of such means, methods, techniques, sequences or procedures.

B.2.2 The Contractor is responsible to protect and maintain the Work during the course of construction and to mitigate any adverse impacts to the project, including those caused by authorized changes, which may affect cost, schedule, or quality.

B.2.3 The Contractor is responsible for the actions of all its personnel, laborers, suppliers, and Subcontractors on the project. The Contractor shall enforce strict discipline and good order among Contractor's employees and other persons carrying out the Work. The Contractor shall not permit employment of persons who are unfit or unskilled for the tasks assigned to them.

B.3 MATERIALS AND WORKMANSHIP

B.3.1 The intent of the Contract Documents is to provide for the construction and completion in every detail of the Work described. All Work shall be performed in a professional manner and unless the means or methods of performing a task are specified elsewhere in the Contract Documents, Contractor shall employ methods that are generally accepted and used by the industry, in accordance with industry standards.

B.3.2 The Contractor is responsible to perform the Work as required by the Contract Documents. Defective Work shall be corrected at the Contractor's expense.

B.3.3 Work done and materials furnished shall be subject to inspection and/or observation and testing by the Owner to determine if they conform to the Contract Documents. Inspection of the Work by the Owner does not relieve the Contractor of responsibility for the Work in accordance with the Contract Documents.

B.3.4 Contractor shall furnish adequate facilities, as required, for the Owner to have safe access to the Work including without limitation walkways, railings, ladders, tunnels, and platforms. Producers, suppliers, and fabricators shall also provide proper facilities and access to their facilities.

B.3.5 The Contractor shall furnish Samples of materials for testing by the Owner and include the cost of the Samples in the Contract Price.

B.4 PERMITS

Except to the extent otherwise directed by Owner, Contractor shall obtain and pay for all necessary permits, licenses and fees, except for those specifically excluded in the Public Improvement Supplemental General Conditions, for the construction of the Work, for temporary obstructions, enclosures, opening of streets for pipes, walls, utilities, environmental Work, etc., as required for the project. Contractor shall be responsible for all violations of the law, in connection with the construction or caused by obstructing streets, sidewalks or otherwise. Contractor shall give all requisite notices to public authorities.

B.5 COMPLIANCE WITH GOVERNMENT REGULATIONS

B.5.1 Contractor shall comply with Applicable Laws pertaining to the Work and the Contract. Failure to comply with such

requirements shall constitute a breach of Contract and shall be grounds for Contract termination. Without limiting the generality of the foregoing, Contractor expressly agrees to comply with the following, as applicable:

(i) Title VI and VII of Civil Rights Act of 1964, as amended; (ii) Section 503 and 504 of the Rehabilitation Act of 1973, as amended; (iii) the Health Insurance Portability and Accountability Act of 1996; (iv) the Americans with Disabilities Act of 1990, as amended; (v) ORS Chapter 659A; as amended; (vi) all regulations and administrative rules established pursuant to the foregoing laws; and (vii) all other applicable requirements of federal and state civil rights and rehabilitation statutes, rules and regulations.

B.5.2 Contractor shall comply with all applicable requirements of federal and state civil rights and rehabilitation statutes, rules and regulations, and

(a) Contractor shall not discriminate against Disadvantaged, Minority, Women or Emerging Small Business enterprises, as those terms are defined in ORS 200.005, or a business enterprise that is owned or controlled by or that employs a disabled veteran, as that term is defined in ORS 408.225, in the awarding of subcontracts.

(b) Contractor shall maintain, in current and valid form, all licenses and certificates required by Applicable Laws or this Contract when performing the Work.

B.5.3 Unless contrary to federal law, Contractor shall certify that it shall not accept a bid from Subcontractors to perform Work as described in ORS 701.005 under this Contract unless such Subcontractors are registered with the Construction Contractors Board in accordance with ORS 701.035 to 701.055 at the time they submit their bids to the Contractor.

B.5.4 Unless contrary to federal law, Contractor shall certify that each landscape contractor, as defined in ORS 671.520(2), performing Work under this Contract holds a valid landscape contractor's license issued pursuant to ORS 671.560.

B.5.5 The following notice is applicable to Contractors who perform excavation Work. "ATTENTION: Oregon law requires you to follow rules adopted by the Oregon Utility Notification Center. Those rules are set forth in OAR 952-001-0010 through OAR 952-001-0090. You may obtain copies of the rules by calling the center at (503)232-1987."

B.5.6 Failure to comply with any or all of the requirements of B.5.1 through B.5.5 shall be a breach of Contract and constitute grounds for Contract termination. Damages or costs resulting from such noncompliance shall be the responsibility of Contractor.

B.6 SUPERINTENDENCE

Contractor shall keep on the site, during the progress of the Work, a competent superintendent and any necessary assistants who shall be satisfactory to the Owner and who shall represent the Contractor on the site. Directions given to the superintendent by the Owner shall be confirmed in writing to the Contractor.

B.7 INSPECTION

B.7.1 Owner shall have access to the Work at all times.

B.7.2 Inspection of the Work will be made by the Owner at its discretion. The Owner will have authority to reject Work that does not conform to the Contract Documents. Any Work found to be not in conformance with the Contract Documents, in the discretion of the Owner, shall be removed and replaced at the Contractor's expense.

B.7.3 Contractor shall make or obtain at the appropriate time all tests, inspections and approvals of portions of the Work required by the Contract Documents or by Applicable Laws or orders of public authorities having jurisdiction. Unless otherwise provided, the Contractor shall make arrangements for such tests, inspections and approvals with an independent testing laboratory or entity acceptable to the Owner, or with the appropriate public authority, and shall bear all related costs of tests, inspections and approvals. Tests or inspections conducted pursuant to the Contract Documents shall be made promptly to avoid unreasonable delay in the Work. The Contractor shall give the Owner timely notice of when and where tests and inspections are to be made so that the Owner may be present for such procedures. Required certificates of testing, inspection or approval shall, unless otherwise required by the Contract Documents, be secured by the Contractor and promptly delivered to the Owner.

B.7.4 As required by the Contract Documents, Work done or material used without required inspection or testing and/or without providing timely notice to the Owner may be ordered removed at the Contractor's expense.

B.7.5 If directed to do so any time before the Work is accepted, the Contractor shall uncover portions of the completed Work for inspection. After inspection, the Contractor shall restore such portions of Work to the standard required by the Contract. If the Work uncovered is unacceptable or was done without required testing or inspection or sufficient notice to the Owner, the uncovering and restoration shall be done at the Contractor's expense. If the Work uncovered is acceptable and was done with sufficient notice to the Owner, the uncovering and restoration will be paid for pursuant to a Change Order.

B.7.6 If any testing or inspection reveals failure of the portions of the Work to comply with requirements established by the Contract Documents, all costs made necessary by such failure, including those of repeated procedures and compensation for the Owner's and Architect/Engineer's services and expenses, shall be at the Contractor's expense.

B.7.7 When the United States government participates in the cost of the Work, or the Owner has an agreement with other public or private organizations, or if any portion of the Work is being performed for a third party or in close proximity to third party facilities, representatives of these organizations shall have the right to inspect the Work affecting their interests or property. Their right to inspect shall not make them a party to the Contract and shall not interfere with the rights of the parties of the Contract. Instructions or orders of such parties shall be transmitted to the Contractor, through the Owner.

B.8 SEVERABILITY

If any provision of this Contract is declared by a court to be illegal or in conflict with any law, the validity of the remaining terms and provisions shall not be affected and the rights and obligations of the parties shall be construed and enforced as if the Contract did not contain the particular provision held to be invalid.

B.9 ACCESS TO RECORDS

B.9.1 Contractor shall keep, at all times on the Work site, one record copy of the complete Contract Documents, including the Plans, Specifications, Construction Change Directives and addenda, in good order and marked currently to record field changes and selections made during construction, and one record copy of Shop Drawings, Product Data, Samples and similar submittals, and shall at all times give the Owner access thereto.

B.9.2 Contractor shall retain and the Owner and its duly authorized representatives shall have access, for a period not less than ten (10) years, to all Record Documents, financial and accounting

records, and other books, documents, papers and records of Contractor which are pertinent to the Contract, including records pertaining to Overhead and indirect costs, for the purpose of making audit, examination, excerpts and transcripts. If for any reason, any part of the Work or this Contract shall be subject to litigation, Contractor shall retain all such records until all litigation is resolved and Contractor shall continue to provide Owner and/or its agents with full access to such records until such time as all litigation is complete and all periods for appeal have expired and full and final satisfaction of any judgment, order or decree is recorded and Owner receives a record copy of documentation from Contractor.

B.10 WAIVER

Failure of the Owner to enforce any provision of this Contract shall not constitute a waiver or relinquishment by the Owner of the right to such performance in the future nor of the right to enforce any other provision of this Contract.

B.11 SUBCONTRACTS AND ASSIGNMENT

B.11.1 Contractor shall require each Subcontractor, to the extent of the Work to be performed by the Subcontractor, to be bound by the terms and conditions of these OUS Public Improvement General Conditions, and to assume toward the Contractor all of the obligations and responsibilities which the Contractor assumes toward the Owner thereunder, unless (1) the same are clearly inapplicable to the subcontract at issue because of legal requirements or industry practices, or (2) specific exceptions are requested by Contractor and approved in writing by Owner. Where appropriate, Contractor shall require each Subcontractor to enter into similar agreements with sub-subcontractors at any level.

B.11.2 At Owner's request, Contractor shall submit to Owner prior to their execution either Contractor's form of subcontract, or the subcontract to be executed with any particular Subcontractor. If Owner disapproves such form, Contractor shall not execute the form until the matters disapproved are resolved to Owner's satisfaction. Owner's review, comment upon or approval of any such form shall not relieve Contractor of its obligations under this Agreement or be deemed a waiver of such obligations of Contractor.

B.11.3 Contractor shall not assign, sell, or transfer its rights, or delegate its responsibilities under this Contract, in whole or in part, without the prior written approval of the Owner. No such written approval shall relieve Contractor of any obligations of this Contract, and any transferee shall be considered the agent of the Contractor and bound to perform in accordance with the Contract Documents. Contractor shall remain liable as between the original parties to the Contract as if no assignment had occurred.

B.12 SUCCESSORS IN INTEREST

The provisions of this Contract shall be binding upon and shall accrue to the benefit of the parties to the Contract and their respective permitted successors and assigns.

B.13 OWNER'S RIGHT TO DO WORK

Owner reserves the right to perform other or additional work at or near the project site with other forces than those of the Contractor. If such work takes place within or next to the project site, Contractor shall coordinate work with the other contractors or forces, cooperate with all other contractors or forces, carry out the Work in a way that will minimize interference and delay for all forces involved, place and dispose of materials being used so as not to interfere with the operations of another, and join the Work with the work of the others in an acceptable manner and perform it in proper sequence to that of the others. The Owner will resolve any disagreements that may arise

between or among Contractor and the other contractors over the method or order of doing all work (including the Work). In case of unavoidable interference, the Owner will establish work priority (including the Work) which generally will be in the sequence that the contracts were awarded.

B.14 OTHER CONTRACTS

In all cases and at any time, the Owner has the right to execute other contracts related to or unrelated to the Work of this Contract. The Contractor of this Contract shall fully cooperate with any and all other contractors without additional cost to the Owner in the manner described in section B.13.

B.15 GOVERNING LAW

This Contract shall be governed by and construed in accordance with the laws of the State of Oregon without regard to principles of conflict of laws.

B.16 LITIGATION

Any Claim between Owner and Contractor that arises from or relates to this Contract and that is not resolved through the Claims Review Process in Section D.3 shall be brought and conducted solely and exclusively within the Circuit Court of Marion County for the State of Oregon, unless stated otherwise in the Contract Documents, provided, however, if a Claim must be brought in a federal forum, then it shall be brought and conducted solely and exclusively within the United States District Court for the District of Oregon. In no event shall this section be construed as a waiver by the State of Oregon of any form of defense or immunity, whether sovereign immunity, governmental immunity, immunity based on the Eleventh Amendment to the Constitution of the United States or otherwise, from any claim or from the jurisdiction of any court. CONTRACTOR, BY EXECUTION OF THIS CONTRACT, HEREBY CONSENTS TO THE IN PERSONAM JURISDICTION OF THE COURTS REFERENCED IN THIS SECTION B.16.

B.17 ALLOWANCES

- B.17.1 The Contractor shall include in the Contract Price all allowances stated in the Contract Documents. Items covered by allowances shall be supplied for such amounts and by such persons or entities as the Owner may direct.
- B.17.2 Unless otherwise provided in the Contract Documents:
- (a) when finally reconciled, allowances shall cover the cost to the Contractor of materials and equipment delivered at the site and all required taxes, less applicable trade discounts;
 - (b) Contractor's costs for unloading and handling at the site, labor, installation costs, Overhead, profit and other expenses contemplated for stated allowance amounts shall be included in the Contract Price but not in the allowances;
 - (c) whenever costs are more than or less than allowances, the Contract Price shall be adjusted accordingly by Change Order. The amount of the Change Order shall reflect (i) the difference between actual costs and the allowances under Section B.17.2(a) and (2) changes in Contractor's costs under Section B.17.2(b).
 - (d) Unless Owner requests otherwise, Contractor shall provide to Owner a proposed fixed price for any allowance work prior to its performance.

B.18 SUBMITTALS, SHOP DRAWINGS, PRODUCT DATA AND SAMPLES

B.18.1 The Contractor shall prepare and keep current, for the Architect's/Engineer's approval (or for the approval of Owner if approval authority has not been delegated to the

Architect/Engineer), a schedule and list of submittals which is coordinated with the Contractor's construction schedule and allows the Architect/Engineer reasonable time to review submittals. Owner reserves the right to finally approve the schedule and list of submittals. Submittals include, without limitation, Shop Drawings, Product Data, and Samples which are described below:

- (a) Shop Drawings are drawings, diagrams, schedules and other data specially prepared for the Work by the Contractor or a Subcontractor (including any sub-subcontractor), manufacturer, supplier or distributor to illustrate some portion of the Work.
- (b) Product Data are illustrations, standard schedules, performance charts, instructions, brochures, diagrams and other information furnished by the Contractor to illustrate materials or equipment for some portion of the Work.
- (c) Samples are physical examples which illustrate materials, equipment or workmanship and establish standards by which the Work will be judged.

B.18.2 Shop Drawings, Product Data, Samples and similar submittals are not Contract Documents. The purpose of their submittal is to demonstrate for those portions of the Work for which submittals are required by the Contract Documents the way by which the Contractor proposes to conform to the information given and the design concept expressed in the Contract Documents. Review of submittals by the Architect/Engineer is not conducted for the purpose of determining the accuracy and completeness of other details such as dimensions and quantities, or for substantiating instructions for installation or performance of equipment or systems, or for approval of safety precautions or, unless otherwise specifically stated by the Architect/Engineer, of any construction means, methods, techniques, sequences or procedures, all of which remain the responsibility of the Contractor as required by the Contract Documents. The Architect/Engineer's review of the Contractor's submittals shall not relieve the Contractor of its obligations under the Contract Documents. The Architect/Engineer's approval of a specific item shall not indicate approval of an assembly of which the item is a component. Informational submittals upon which the Architect/Engineer is not expected to take responsive action may be so identified in the Contract Documents. Submittals which are not required by the Contract Documents may be returned by the Architect/Engineer without action.

B.18.3 The Contractor shall review for compliance with the Contract Documents, approve and submit to the Architect/Engineer Shop Drawings, Product Data, Samples and similar submittals required by the Contract Documents with reasonable promptness and in such sequence as to cause no delay in the Work or in the activities of the Owner or of separate contractors. Submittals which are not marked as reviewed for compliance with the Contract Documents and approved by the Contractor may be returned by the Architect/Engineer without action.

B.18.4 By approving and submitting Shop Drawings, Product Data, Samples and similar submittals, the Contractor represents that the Contractor has determined and verified materials, field measurements and field construction criteria related thereto, or will do so, and has checked and coordinated the information contained within such submittals with the requirements of the Work and of the Contract Documents.

B.18.5 The Contractor shall perform no portion of the Work for which the Contract Documents require submittal and review of Shop Drawings, Product Data, Samples or similar submittals until the respective submittal has been approved by the Architect/Engineer.

B.18.6 The Work shall be in accordance with approved submittals except that the Contractor shall not be relieved of responsibility for deviations from requirements of the Contract Documents by the Architect/Engineer's review or approval of Shop Drawings, Product Data, Samples or similar submittals unless the Contractor has specifically informed the Architect/Engineer in writing of such deviation at the time of submittal and (i) the Architect/Engineer has given written approval to the specific deviation as a minor change in the Work, or (ii) a Change Order or Construction Change Directive has been executed by Owner authorizing the deviation. The Contractor shall not be relieved of responsibility for errors or omissions in Shop Drawings, Product Data, Samples or similar submittals by the Architect/Engineer's review or approval thereof.

B.18.7 In the event that Owner elects not to have the obligations and duties described under this Section B.18 performed by the Architect/Engineer, or in the event no Architect/Engineer is employed by Owner on the project, all obligations and duties assigned to the Architect/Engineer hereunder shall be performed by the Owner.

B.19 SUBSTITUTIONS

The Contractor may make Substitutions only with the consent of the Owner, after evaluation by the Owner and only in accordance with a Change Order or Construction Change Directive. Substitutions shall be subject to the requirements of the Bid documents. By making requests for Substitutions, the Contractor: represents that the Contractor has personally investigated the proposed substitute product; represents that the Contractor will provide the same warranty for the Substitution that the Contractor would for the product originally specified unless approved otherwise; certifies that the cost data presented is complete and includes all related costs under this Contract including redesign costs, and waives all claims for additional costs related to the Substitution which subsequently become apparent; and will coordinate the installation of the accepted Substitution, making such changes as may be required for the Work to be completed in all respects.

B.20 USE OF PLANS AND SPECIFICATIONS

Plans, Specifications and related Contract Documents furnished to Contractor by Owner or Owner's Architect/Engineer shall be used solely for the performance of the Work under this Contract. Contractor and its Subcontractors and suppliers are authorized to use and reproduce applicable portions of such documents appropriate to the execution of the Work, but shall not claim any ownership or other interest in them beyond the scope of this Contract, and no such interest shall attach. Unless otherwise indicated, all common law, statutory and other reserved rights, in addition to copyrights, are retained by Owner.

B.21 FUNDS AVAILABLE AND AUTHORIZED

Owner reasonably believes at the time of entering into this Contract that sufficient funds are available and authorized for expenditure to finance the cost of this Contract within the Owner's appropriation or limitation. Contractor understands and agrees that, to the extent that sufficient funds are not available and authorized for expenditure to finance the cost of this Contract, Owner's payment of amounts under this Contract attributable to Services performed after the last day of the current biennium is contingent on Owner receiving from the Oregon Legislative Assembly appropriations, limitations or other expenditure authority sufficient to allow Owner, in the exercise of its reasonable administrative discretion, to continue to make payments under this Contract.

B.22 NO THIRD PARTY BENEFICIARIES

Owner and Contractor are the only parties to this Contract and are the only parties entitled to enforce its terms. Nothing in this Contract gives, is intended to give, or shall be construed to give or

provide any benefit or right, whether directly, indirectly, or otherwise, to third persons unless such third persons are individually identified by name herein and expressly described as intended beneficiaries of the terms of this Contract.

SECTION C WAGES AND LABOR

C.1 MINIMUM WAGE RATES ON PUBLIC WORKS

Contractor shall comply fully with the provisions of ORS 279C.800 through 279C.870. Documents establishing those conditions, as determined by the Commissioner of the Bureau of Labor and Industries (BOLI), are included as attachments to or are incorporated by reference in the Contract Documents. Pursuant to ORS 279C.830(1)(d), Contractor shall pay workers at not less than the specified minimum hourly rate of wage, and shall include that requirement in all subcontracts. If the Work is subject to both the state prevailing wage rate law and the federal Davis-Bacon Act, Contractor shall pay the higher of the applicable state or federal prevailing rate of wage. Contractor shall provide written notice to all workers of the number of hours per day and days per week such workers may be required to work.

C.2 PAYROLL CERTIFICATION AND FEE REQUIREMENTS

C.2.1 In accordance with ORS 279C.845, the Contractor and every Subcontractor shall submit written certified statements to the Owner, on the form prescribed by the Commissioner of the Bureau of Labor and Industries, certifying the hourly rate of wage paid each worker which the Contractor or the Subcontractor has employed on the project and further certifying that no worker employed on the project has been paid less than the prevailing rate of wage or less than the minimum hourly rate of wage specified in the Contract, which certificate and statement shall be verified by the oath of the Contractor or the Subcontractor that the Contractor or Subcontractor has read the certified statement, that the Contractor or Subcontractor knows the contents of the certified statement, and, that to the Contractor's or Subcontractor's best knowledge and belief, the certified statement is true. The certified statements shall set out accurately and completely the payroll records for the prior week, including the name and address of each worker, the worker's correct classification, rate of pay, daily and weekly number of hours worked, deductions made, and actual wages paid. Certified statements for each week during which the Contractor or Subcontractor has employed a worker on the project shall be submitted once a month, by the fifth business day of the following month. The Contractor and Subcontractors shall preserve the certified statements for a period of ten (10) years from the date of completion of the Contract.

C.2.2 Pursuant to ORS 279C.845(7), the Owner shall retain 25 percent of any amount earned by the Contractor on this public works project until the Contractor has filed the certified statements required by section C.2.1. The Owner shall pay to the Contractor the amount retained under this subsection within 14 days after the Contractor files the required certified statements, regardless of whether a Subcontractor has failed to file certified statements.

C.2.3 Pursuant to ORS 279C.845(8), the Contractor shall retain 25 percent of any amount earned by a first-tier Subcontractor on this public works project until the first-tier Subcontractor has filed with the Owner the certified statements required by C.2.1. Before paying any amount retained under this subsection, the Contractor shall verify that the first-tier Subcontractor has filed the certified statement. Within 14 days after the first-tier Subcontractor files the required certified statement the

Contractor shall pay the first-tier Subcontractor any amount retained under this subsection.

- C.2.4 In accordance with statutory requirements and administrative rules promulgated by the Commissioner of the Bureau of Labor and Industries, the fee required by ORS 279C.825(1) will be paid by Owner to the Commissioner.

C.3 PROMPT PAYMENT AND CONTRACT CONDITIONS

C.3.1 As a condition to Owner's performance hereunder, the Contractor shall:

- C.3.1.1 Make payment promptly, as due, to all persons supplying to Contractor labor or materials for the prosecution of the Work provided for in this Contract.
- C.3.1.2 Pay all contributions or amounts due the State Industrial Accident Fund from such Contractor or Subcontractor incurred in the performance of the Contract.
- C.3.1.3 Not permit any lien or claim to be filed or prosecuted against the Owner on account of any labor or material furnished. Contractor will not assign any claims that Contractor has against Owner, or assign any sums due by Owner, to Subcontractors, suppliers, or manufacturers, and will not make any agreement or act in any way to give Subcontractors a claim or standing to make a claim against the Owner.
- C.3.1.4 Pay to the Department of Revenue all sums withheld from employees pursuant to ORS 316.167.
- C.3.2 As a condition to Owner's performance hereunder, if Contractor fails, neglects or refuses to make prompt payment of any claim for labor or services furnished to the Contractor or a Subcontractor by any person in connection with the project as such claim becomes due, the proper officer(s) representing the Owner may pay the claim and charge the amount of the payment against funds due or to become due Contractor under this Contract. Payment of claims in this manner shall not relieve the Contractor or the Contractor's surety from obligation with respect to any unpaid claims.
- C.3.3 Contractor shall include in each subcontract for property or services entered into by the Contractor and a first-tier subcontractor, including a material supplier, for the purpose of performing a construction contract, a payment clause that obligates the Contractor to pay the first-tier Subcontractor for satisfactory performance under its subcontract within ten (10) Days out of such amounts as are paid to the Contractor by the public contracting agency under such contract.
- C.3.4 All employers, including Contractor, that employ subject workers who work under this contract in the State of Oregon shall comply with ORS 656.017 and provide the required Workers' Compensation coverage, unless such employers are exempt under ORS 656.126. Contractor shall ensure that each of its Subcontractors complies with these requirements.

C.4 PAYMENT FOR MEDICAL CARE

As a condition to Owner's performance hereunder, Contractor shall promptly, as due, make payment to any person, partnership, association or corporation furnishing medical, surgical, and hospital care or other needed care and attention, incident to sickness or injury, to the employees of such Contractor, all sums of which the Contractor agrees to pay for such services and all moneys and sums which the Contractor has collected or deducted from the wages of personnel pursuant to any law, contract or agreement for the purpose of providing or paying for such services.

C.5 HOURS OF LABOR

As a condition to Owner's performance hereunder, no person shall be employed to perform Work under this Contract for more than ten (10) hours in any one day or forty (40) hours in any one week, except in cases of necessity, emergency or where public policy absolutely requires it. In such instances, Contractor shall pay the employee at least time and a half pay:

- (a) For all overtime in excess of eight (8) hours a day or forty (40) hours in any one week when the work week is five consecutive Days, Monday through Friday; or
- (b) For all overtime in excess of ten (10) hours a day or forty (40) hours in any one week when the work week is four consecutive Days, Monday through Friday; and
- (c) For all Work performed on Saturday and on any legal holiday specified in ORS 279C.540.

This section C.5 will not apply to Contractor's Work under this Contract to the extent Contractor is currently a party to a collective bargaining agreement with any labor organization.

This Section C.5 shall not excuse Contractor from completion of the Work within the time required under this Contract.

SECTION D CHANGES IN THE WORK

D.1 CHANGES IN WORK

- D.1.1 The terms of this Contract shall not be waived, altered, modified, supplemented or amended in any manner whatsoever, without prior written agreement and then only after any necessary approvals have been obtained. A Change Order is required, which shall not be effective until its execution by the parties to this Contract and all approvals required by public contracting laws have been obtained.
- D.1.2 It is mutually agreed that changes in Plans, quantities, or details of construction are inherent in the nature of construction and may be necessary or desirable during the course of construction. Within the general scope of this Contract, the Owner may at any time, without notice to the sureties and without impairing the Contract, require changes consistent with this Section D.1. All changes to the Work shall be documented and Change Orders shall be executed under the conditions of the Contract Documents. Such changes may include, but are not limited to:
- (a) Modification of specifications and design.
- (b) Increases or decreases in quantities.
- (c) Increases or decreases to the amount of Work.
- (d) Addition or elimination of any Work item.
- (e) Change in the duration of the project.
- (f) Acceleration or delay in performance of Work.
- (g) Deductive changes.

Deductive changes are those that reduce the scope of the Work, and shall be made by mutual agreement whenever feasible. In cases of suspension or partial termination under Section J, Owner reserves the right to unilaterally impose a deductive change and to self perform such Work, for which the provisions of B.13 (Owner's Right to Do Work) shall then apply. Adjustments in compensation shall be made under the provisions of D.1.3, in which costs for deductive changes shall be based upon a Direct Costs adjustment together with the related percentage markup specified for profit, Overhead and other indirect costs, unless otherwise agreed to by Owner.

- D.1.3 The Owner and Contractor agree that adjustments to or deletions from the Work shall be administered and compensated according to the following:

- (a) Unit pricing may be utilized at the Owner’s option when unit prices or solicitation alternates were provided that established the cost for adjustments to Work, and a binding obligation exists under the Contract on the parties covering the terms and conditions of the adjustment to Work.
- (b) If the Owner elects not to utilize unit pricing, or in the event that unit pricing is not available or appropriate, fixed pricing may be used for adjustments to or deletions from the Work. In fixed pricing the basis of payments or total price shall be agreed upon in writing between the parties to the Contract, and shall be established before the Work is done whenever feasible. Notwithstanding the foregoing, the mark-ups set forth in D.1.3(c) shall be utilized in establishing fixed pricing, and such mark-ups shall not be exceeded. Cost and price data relating to adjustments to or deletions from the Work shall be supplied by Contractor to Owner upon request, but Owner shall be under no obligation to make such requests.
- (c) In the event that unit pricing and fixed pricing are not utilized, then adjustments to or deletions from the Work shall be performed on a cost reimbursement basis for Direct Costs. Such Work shall be compensated on the basis of the actual, reasonable and allowable cost of labor, equipment, and material furnished on the Work performed. In addition, the following markups shall be added to the Contractor’s or Subcontractor’s Direct Costs as full compensation for profit, Overhead and other indirect costs for Work directly performed with the Contractor’s or Subcontractor’s own forces:

On Labor.....	15%
On Equipment.....	10%
On Materials.....	10%

- (d) When adjustments to or deletions from the Work under D.1.3(c) are invoiced by an authorized Subcontractor at any level, each ascending tier Subcontractor or Contractor will be allowed a supplemental mark-up on each piece of subcontract Work covered by a Change Order as follows:

\$0.00 - \$5,000.00	10%, and then
Over \$5,000.00	5%

Payments made to the Contractor shall be complete compensation for Overhead, profit, and all costs that were incurred by the Contractor or by other forces furnished by the Contractor, including Subcontractors, for adjustments to or deletions from the Work pursuant to a Change Order. Owner may establish a maximum cost for additional Work under this Section D.1.3, which shall not be exceeded for reimbursement without additional written authorization from Owner in the form of a Change Order. Contractor shall not be required to complete such additional Work without additional authorization.

- D.1.4 Any necessary adjustment of Contract Time that may be required as a result of adjustments to or deletions from the Work must be agreed upon by the parties before the start of the revised Work unless Owner authorizes Contractor to start the revised Work before agreement on Contract Time adjustment. Contractor shall submit any request for additional compensation (and additional Contract Time if Contractor was authorized to start Work before an adjustment of Contract Time was approved) as soon as possible but no later than thirty (30) Days after receipt of Owner’s request for additional Work. If Contractor’s request for additional compensation or adjustment of Contract Time is not made within the thirty (30) Day time limit, Contractor’s requests pertaining to that additional Work shall be barred. The thirty (30) Day time limit for making requests shall not be extended for any reason, including without

limitation Contractor’s claimed inability to determine the amount of additional compensation or adjustment of Contract Time, unless an extension is granted in writing by Owner. If the Owner denies Contractor’s request for additional compensation or adjustment of Contract Time, Contractor may proceed to file a Claim under Section D.3, Claims Review Process. No other reimbursement, compensation, or payment will be made, except as provided in Section D.1.5 for impact claims.

- D.1.5 If any adjustment to Work under Section D.1.3 causes an increase or decrease in the Contractor’s cost of, or the Contract Time required for the performance of any other part of the Work under this Contract, Contractor shall submit a written request to the Owner, setting forth the nature and specific extent of the request, including all time and cost impacts against the Contract as soon as possible, but no later than thirty (30) Days after receipt of Owner’s request for adjustments to or deletions from the Work by Contractor.

The thirty (30) Day time limit applies to claims of Subcontractors, suppliers, or manufacturers who may be affected by Owner’s request for adjustments to or deletions from the Work and who request additional compensation or an extension of Contract Time to perform; Contractor has responsibility for contacting its Subcontractors, suppliers, or manufacturers within the thirty (30) Day time limit, and including their requests with Contractor’s requests. If the request involves Work to be completed by Subcontractors, or materials to be furnished by suppliers or manufacturers, such requests shall be submitted to the Contractor in writing with full analysis and justification for the adjustments to compensation and Contract Time requested. The Contractor shall analyze and evaluate the merits of the requests submitted by Subcontractors, suppliers, and manufacturers to Contractor prior to including those requests and Contractor’s analysis and evaluation of those requests with Contractor’s requests for adjustments to compensation or Contract Time that Contractor submits to the Owner. Failure of Subcontractors, suppliers, manufacturers or others to submit their requests to Contractor for inclusion with Contractor’s requests submitted to Owner within the time period and by the means described in this section shall constitute a waiver of these Subcontractor claims. The Owner will not consider direct requests or claims from Subcontractors, suppliers, manufacturers or others not a party to this Contract. The consideration of such requests and claims under this section does not give any Person, not a party to the Contract the right to bring a claim against Owner, whether in this claims process, in litigation, or in any dispute resolution process.

If the Owner denies the Contractor’s request for adjustment to compensation or Contract Time, the Contractor may proceed to file a Claim under Section D.3, Claims Review Process.

- D.1.6 No request or Claim by the Contractor for additional costs or an adjustment of Contract Time shall be allowed if made after receipt of final payment application under this Contract. Final payment application must be made by Contractor within the time required under Section E.6.4.
- D.1.7 It is understood that changes in the Work are inherent in construction of this type. The number of changes, the scope of those changes, and the effect they have on the progress of the original Work cannot be defined at this time. The Contractor is notified that numerous changes may be required and that there will be no compensation made, unless and only to the extent otherwise provided in the Contract Documents, to the Contractor directly related to the number of changes. Each change will be evaluated for extension of Contract Time and increase or decrease in compensation based on its own merit.

D.2 DELAYS

D.2.1 Delays in construction include "Avoidable Delays", which are defined in Section D.2.1.1, and "Unavoidable Delays", which are defined in Section D.2.1.2. The effect of Avoidable Delays is described in Section D.2.2 and the effect of Unavoidable Delays is described in Section D.2.3.

D.2.1.1 Avoidable Delays include any delays other than Unavoidable Delays, and include delays that otherwise would be considered Unavoidable Delays but that:

- (a) Could have been avoided by the exercise of care, prudence, foresight, and diligence on the part of the Contractor or its Subcontractors.
- (b) Affect only a portion of the Work and do not necessarily prevent or delay the prosecution of neither other parts of the Work nor the completion of the whole Work within the Contract Time.
- (c) Do not impact activities on the accepted critical path schedule.
- (d) Are associated with the reasonable interference of other contractors employed by the Owner that do not necessarily prevent the completion of the whole Work within the Contract Time.

D.2.1.2 Unavoidable Delays include delays other than Avoidable Delays that are:

- (a) To the extent caused by any actions of the Owner, or any other employee or agent of the Owner, or by separate contractor employed by the Owner.
- (b) To the extent caused by any site conditions which differ materially from what was represented in the Contract Documents or from conditions that would normally be expected to exist and be inherent to the construction activities defined in the Contract Documents. The Contractor shall notify the Owner immediately of differing site conditions before the area has been disturbed. The Owner will investigate the area and make a determination as to whether or not the conditions differ materially from either the conditions stated in the Contract Documents or those which could reasonably be expected in execution of this particular Contract. If Contractor and the Owner agree that a differing site condition exists, any adjustment to compensation or Contract Time will be determined based on the process set forth in Section D.1.5 for adjustments to or deletions from Work. If the Owner disagrees that a differing site condition exists and denies Contractor's request for additional compensation or Contract Time, Contractor may proceed to file a Claim under Section D.3, Claims Review Process.
- (c) To the extent caused by Force Majeure acts, events or occurrences that could not have been avoided by the exercise of care, prudence, foresight, and diligence on the part of the Contractor or its Subcontractors.
- (d) To the extent caused by adverse weather conditions. Any adverse weather conditions must be substantiated by documentary evidence that weather conditions were abnormal for the specific time period claimed, could not have been anticipated by the Contractor, and adversely impacted the project in a manner that could not be avoided by rescheduling the Work or by implementing measures to protect against the weather so that the Work could proceed. A rain, windstorm, high water, or other natural phenomenon for the specific locality of the Work, which might reasonably have been anticipated from the previous 10-year historical records of the general locality of the Work, shall not be construed as abnormal. The parties

agree that rainfall greater than the following levels cannot be reasonably anticipated:

- (i) Daily rainfall equal to, or greater than, 0.50 inch during a month when the monthly rainfall exceeds the normal monthly average by twenty-five percent (25 %) or more.
- (ii) daily rainfall equal to, or greater than, 0.75 inch at any time.

The Office of the Environmental Data Service of the National Oceanic and Atmospheric Administration of the U.S. Department of Commerce nearest the project site shall be considered the official agency of record for weather information.

D.2.2 Contractor shall not be entitled to additional compensation or additional Contract Time for Avoidable Delays.

D.2.3 In the event of Unavoidable Delays, based on principles of equitable adjustment, Contractor may be entitled to the following:

- (a) Contractor may be entitled to additional compensation or additional Contract Time, or both, for Unavoidable Delays described in Section D.2.1.2 (a) and (b).
- (b) Contractor may be entitled to additional Contract Time for Unavoidable Delays described in Section D.2.1.2(c) and (d).

In the event of any requests for additional compensation or additional Contract Time, or both, as applicable, arising under this Section D.2.3 for Unavoidable Delays, other than requests for additional compensation or additional Contract Time for differing site conditions for which a review process is established under Section D.2.1.2 (b), Contractor shall submit a written notification of the delay to the Owner within two (2) Days of the occurrence of the cause of the delay. This written notification shall state the cause of the potential delay, the project components impacted by the delay, and the anticipated additional Contract Time extension or the additional compensation, or both, as applicable, resulting from the delay. Within seven (7) Days after the cause of the delay has been mitigated, or in no case more than thirty (30) Days after the initial written notification, the Contractor shall submit to the Owner, a complete and detailed request for additional compensation or additional Contract Time, or both, as applicable, resulting from the delay. If the Owner denies Contractor's request for additional compensation or adjustment of Contract Time, the Contractor may proceed to file a Claim under Section D.3, Claims Review Process.

If Contractor does not timely submit the notices required under this Section D.2, then unless otherwise prohibited by law, Contractor's Claim shall be barred.

D.3 CLAIMS REVIEW PROCESS

D.3.1 All Contractor Claims shall be referred to the Owner for review. Contractor's Claims, including Claims for adjustments to compensation or Contract Time, shall be submitted in writing by Contractor to the Owner within five (5) Days after a denial of Contractor's initial request for an adjustment of Contract terms, payment of money, extension of Contract Time or other relief, provided that such initial request has been submitted in accordance with the requirements and within the time limits established in these OUS Public Improvement General Conditions. Within thirty (30) Days after the initial Claim, Contractor shall submit to the Owner a complete and detailed description of the Claim (the "Detailed Notice") that includes all information required by Section D.3.2. Unless the Claim is

made in accordance with these time requirements, it shall be waived by Contractor.

- D.3.2 The Detailed Notice of the Claim shall be submitted in writing by Contractor and shall include a detailed, factual statement of the basis of the Claim, pertinent dates, Contract provisions which support or allow the Claim, reference to or copies of any documents which support the Claim, the dollar value of the Claim, and the Contract Time adjustment requested for the Claim. If the Claim involves Work to be completed by Subcontractors, the Contractor will analyze and evaluate the merits of the Subcontractor claim prior to forwarding it and that analysis and evaluation to the Owner. The Owner will not consider direct claims from Subcontractors, suppliers, manufacturers, or others not a party to this Contract. Contractor agrees that it will make no agreement, covenant, or assignment, nor will it commit any other act that will permit or assist any Subcontractor, supplier, manufacturer, or other to directly or indirectly make a claim against Owner.
- D.3.3 The Owner will review all Claims and take one or more of the following preliminary actions within ten (10) Days of receipt of the Detailed Notice of a Claim: (1) request additional supporting information from the Contractor; (2) inform the Contractor and Owner in writing of the time required for adequate review and response; (3) reject the Claim in whole or in part and identify the reasons for rejection; (4) based on principles of equitable adjustment, recommend approval of all or part of the Claim; or (5) propose an alternate resolution.
- D.3.4 The Owner's decision shall be final and binding on the Contractor unless appealed by written notice to the Owner within fifteen (15) Days of receipt of the decision. The Contractor must present written documentation supporting the Claim within fifteen (15) Days of the notice of appeal. After receiving the appeal documentation, the Owner shall review the materials and render a decision within thirty (30) Days after receiving the appeal documents.
- D.3.5 The decision of the Owner shall be final and binding unless the Contractor delivers to the Owner its request for mediation, which shall be a non-binding process, within fifteen (15) Days of the date of the Owner's decision. The mediation process will be considered to have commenced as of the date the Contractor delivers the request. Both parties acknowledge and agree that participation in mediation is a prerequisite to commencement of litigation of any disputes relating to the Contract. Both parties further agree to exercise their best efforts in good faith to resolve all disputes within sixty (60) Days of the commencement of the mediation through the mediation process set forth herein.

In the event that a lawsuit must be filed within this sixty (60) Day period in order to preserve a cause of action, the parties agree that, notwithstanding the filing, they shall proceed diligently with the mediation to its conclusion prior to actively prosecuting the lawsuit, and shall seek from the Court in which the lawsuit is pending such stays or extensions, including the filing of an answer, as may be necessary to facilitate the mediation process. Further, in the event settlements are reached on any issues through mediation, the plaintiff shall promptly cause to be entered by the Court a stipulated general judgment of dismissal with prejudice, or other appropriate order limiting the scope of litigation as provided in the settlement.

- D.3.6 Should the parties arrive at an impasse regarding any Claims or disputed Claims, it is agreed that the parties shall participate in mediation as specified in Section D.3.5. The mediation process will be considered to have been commenced as of the date one party delivers to the other its request in writing to mediate. The mediator shall be an individual mutually acceptable to both parties, but in the absence of agreement each party shall select a temporary mediator and the temporary mediators shall jointly

select the permanent mediator. Each party shall pay its own costs for the time and effort involved in mediation. The cost of the mediator shall be split equally between the two parties. Both parties agree to exercise their best effort in good faith to resolve all disputes in mediation. Participation in mediation is a mandatory requirement of both the Owner and the Contractor. The schedule, time and place for mediation will be mutually acceptable, or, failing mutual agreement, shall be as established by the mediator. The parties agree to comply with Owner's administrative rules governing the confidentiality of mediation, if any, and shall execute all necessary documents to give effect to such confidentiality rules. In any event, the parties shall not subpoena the mediator or otherwise require the mediator to produce records, notes or work product, or to testify in any future proceedings as to information disclosed or representations made in the course of mediation, except to the extent disclosure is required by law.

- D.3.7 Unless otherwise directed by Owner, Contractor shall proceed with the Work while any Claim, or mediation or litigation arising from a Claim, is pending. Regardless of the review period or the final decision of the Owner, the Contractor shall continue to diligently pursue the Work as identified in the Contract Documents. In no case is the Contractor justified or allowed to cease or Delay Work, in whole or in part, without a written stop work order from the Owner.

SECTION E PAYMENTS

E.1 SCHEDULE OF VALUES

The Contractor shall submit, at least ten (10) Days prior to submission of its first application for progress payment, a schedule of values ("Schedule of Values") for the contracted Work. This schedule shall provide a breakdown of values for the contracted Work and will be the basis for progress payments. The breakdown shall demonstrate reasonable, identifiable, and measurable components of the Work. Unless objected to by the Owner, this schedule shall be used as the basis for reviewing Contractor's applications for payment. If objected to by Owner, Contractor shall revise the schedule of values and resubmit the same for approval of Owner.

E.2 APPLICATIONS FOR PAYMENT

E.2.1 Owner shall make progress payments on the Contract monthly as Work progresses, in accordance with the requirements of this Section E.2. Applications for payment shall be based upon estimates of Work completed and the Schedule of Values. As a condition precedent to Owner's obligation to pay, all applications for payment shall be approved by the Owner. A progress payment shall not be considered acceptance or approval of any Work or waiver of any defects therein. Owner shall pay to Contractor interest for overdue invoices at the rate of two-thirds of one percent per month on the progress payment, not including retainage, due the Contractor. Overdue invoices will be those that have not been paid within forty five (45) days from the latest of:

- (a) The date of the receipt of the accurate invoice;
- (b) The date Owner receives the correct application for payment if no invoice is received;
- (c) The date all goods and services have been received; or
- (d) The date a Claim is made certain by agreement of the parties or by operation of law.

Notwithstanding the foregoing, in instances when an application for payment is filled out incorrectly, or when there is any defect or impropriety in any submitted application or when there is a good faith dispute, Owner shall so notify the Contractor within

fifteen (15) Days stating the reason or reasons the application for payment is defective or improper or the reasons for the dispute. A defective or improper application for payment, if corrected by the Contractor within seven (7) Days of being notified by the Owner, shall not cause a payment to be made later than specified in this section unless interest is also paid. Payment of interest will be postponed when payment on the principal is delayed because of disagreement between the Owner and the Contractor.

Owner reserves the right, instead of requiring the Contractor to correct or resubmit a defective or improper application for payment, to reject the defective or improper portion of the application for payment and pay the remainder of the application for such amounts which are correct and proper.

Owner, upon written notice to the Contractor, may elect to make payments to the Contractor only by means of Electronic Funds Transfers (EFT) through Automated Clearing House (ACH) payments. If Owner makes this election, the Contractor shall arrange for receipt of the EFT/ACH payments.

E.2.2 Contractor shall submit to the Owner an application for each payment and, if required, receipts or other vouchers showing payments for materials and labor including payments to Subcontractors. Contractor shall include in its application for payment a schedule of the percentages of the various parts of the Work completed, based on the Schedule of Values which shall aggregate to the payment application total, and shall include, on the face of each copy thereof, a certificate in substantially the following form:

"I, the undersigned, hereby certify that the above bill is true and correct, and the payment therefore, has not been received.

Signed: _____
Dated: _____"

E.2.3 Generally, applications for payment will be accepted only for materials that have been installed. Under special conditions, applications for payment for stored materials will be accepted at Owner's sole discretion. Such a payment, if made, will be subject to the following conditions:

- (a) The request for stored material shall be submitted at least thirty (30) Days in advance of the application for payment on which it appears. Applications for payment shall be entertained for major equipment, components or expenditures only.
- (b) The Contractor shall submit applications for payment showing the quantity and cost of the material stored.
- (c) The material shall be stored in a bonded warehouse and Owner shall be granted the right to access the material for the purpose of removal or inspection at any time during the Contract Period.
- (d) The Contractor shall name the Owner as co-insured on the insurance policy covering the full value of the property while in the care and custody of the Contractor until it is installed. A certificate noting this coverage shall be issued to the Owner.
- (e) Payments shall be made for materials and equipment only. The submitted amount in the application for payment shall be reduced by the cost of transportation from the storage site to the project site and for the cost of an inspector to verify delivery and condition of the goods at the storage site. The cost of storage and inspection shall be borne solely by the Contractor.
- (f) Within sixty (60) Days of the application for payment, the Contractor shall submit evidence of payment covering the material and/or equipment stored and of payment for the storage site.

(g) Payment for stored materials and/or equipment shall in no way indicate acceptance of the materials and/or equipment or waive any rights under this Contract for the rejection of the Work or materials and/or equipment not in conformance with the Contract Documents.

(h) All required documentation shall be submitted with the respective application for payment.

E.2.4 The Owner reserves the right to withhold all or part of a payment, or may nullify in whole or part any payment previously made, to such extent as may be necessary in the Owner's opinion to protect the Owner from loss because of:

- (a) Work that is defective and not remedied, or that has been demonstrated or identified as failing to conform with Applicable Laws or the Contract Documents,
- (b) third party claims filed or evidence reasonably indicating that such claims will likely be filed unless security acceptable to the Owner is provided by the Contractor;
- (c) failure of the Contractor to make payments properly to Subcontractors or for labor, materials or equipment (in which case Owner may issue checks made payable jointly to Contractor and such unpaid Persons under this provision, or directly to Subcontractors and suppliers at any level under Section C.3.2.1);
- (d) reasonable evidence that the Work cannot be completed for the unpaid balance of the Contract Price;
- (e) damage to the Work, Owner or another contractor;
- (f) reasonable evidence that the Work will not be completed within the Contract Time required by the Contract, and that the unpaid balance would not be adequate to cover actual or liquidated damages for the anticipated delay;
- (g) failure to carry out the Work in accordance with the Contract Documents; or
- (h) assessment of liquidated damages, when withholding is made for offset purposes.

E.2.5 Subject to the provisions of the Contract Documents, the amount of each progress payment shall be computed as follows:

- (a) Take that portion of the Contract Price properly allocable to completed Work as determined by multiplying the percentage completion of each portion of the Work by the share of the total Contract Price allocated to that portion of the Work in the Schedule of Values, less retainage as provided in Section E.5. Pending final determination of cost to the Owner of changes in the Work, no amounts for changes in the Work can be included in applications for payment until the Contract Price has been adjusted by a Change Order;
- (b) Add that portion of the Contract Price properly allocable to materials and equipment delivered and suitably stored at the site for subsequent incorporation in the completed construction (or, if approved in advance by the Owner pursuant to Section E.2.3, suitably stored off the site at a location agreed upon in writing), less retainage as provided in Section E.5;
- (c) Subtract the aggregate of previous payments made by the Owner; and
- (d) Subtract any amounts for which the Owner has withheld or nullified payment as provided in the Contract Documents.

E.2.6 Contractor's applications for payment shall not include requests for payment for portions of the Work for which the Contractor does not intend to pay to a Subcontractor or material supplier.

E.2.7 The Contractor warrants to Owner that title to all Work covered by an application for payment will pass to the Owner no later than the time of payment. The Contractor further warrants that upon submittal of an application for payment all Work for which payments are received from the Owner shall be free and clear of liens, claims, security interests or encumbrances in favor of the Contractor, Subcontractors, material suppliers, or other persons or entities making a claim by reason of having provided financing, labor, materials and equipment relating to the Work.

E.2.8 If Contractor disputes any determination by Owner with regard to any application for payment, Contractor nevertheless shall continue to expeditiously perform the Work. No payment made hereunder shall be or be construed to be final acceptance or approval of that portion of the Work to which such partial payment relates or shall relieve Contractor of any of its obligations hereunder.

E.2.9 Contractor shall submit its initial MWESB Report within ten (10) Days of Contractor's execution of the Contract. Contractor shall submit annual MWESB Reports on June 30 of each year the Contract is active. Contracts - first executed by Contractor within ninety (90) Days before June 30 of the year of execution by Contractor may at the discretion of Owner be exempt from submitting the annual MWESB Report otherwise due on that June 30. The final MWESB Report shall be filed with the application for final payment. Timely receipt of MWESB Reports by Owner shall be a condition precedent to Owner's obligation to pay any progress payments or final payment otherwise due.

E.3 PAYROLL CERTIFICATION REQUIREMENT

Owner's receipt of payroll certification pursuant to Section C.2 of this Contract shall be a condition precedent to Owner's obligation to pay any progress payments or final payment otherwise due.

E.4 DUAL PAYMENT SOURCES

Contractor shall not be compensated for Work performed under this Contract from any state agency other than the agency that is a party to this Contract.

E.5 RETAINAGE

E.5.1 Retainage shall be withheld and released in accordance with the requirements set forth in OAR 580-063-0045.

E.5.1.1 Owner may reserve as retainage from any progress payment an amount not to exceed five percent of the payment. As Work progresses, Owner may reduce the amount of retainage on or may eliminate retainage on any remaining monthly Contract payments after 50 percent of the Work under the Contract is completed if, in the Owner's discretion, such Work is progressing satisfactorily. Elimination or reduction of retainage shall be allowed only upon written application by the Contractor, which application shall include written approval of Contractor's surety; except that when the Work is 97-1/2 percent completed the Owner may, at its discretion and without application by the Contractor, reduce the retained amount to 100 percent of the value of the Work remaining to be done. Upon receipt of written application by the Contractor, Owner shall respond in writing within a reasonable time.

E.5.1.2 Contractor may request in writing:

(a) to be paid amounts which would otherwise have been retained from progress payments where Contractor has deposited acceptable bonds and securities of equal value with Owner or in a custodial account or other mutually-agreed account satisfactory to Owner, with an approved bank or trust company to be held in lieu of the cash retainage for the benefit of Owner;

(b) for construction projects over \$1,000,000, that retainage be deposited in an interest bearing account, established through the State Treasurer for state agencies, in a bank, savings bank, trust company or savings association for the benefit of Owner, with earnings from such account accruing to the Contractor; or

(c) that the Owner allow Contractor to deposit a surety bond for the benefit of Owner, in a form acceptable to Owner, in lieu of all or a portion of funds retained, or to be retained. Such bond and any proceeds therefrom shall be made subject to all claims in the manner and priority as set forth for retainage.

When the Owner has accepted the Contractor's election of option (a) or (b), Owner may recover from Contractor any additional costs incurred through such election by reducing Contractor's final payment. Where the Owner has agreed to Contractor's request for option (c), Contractor shall accept like bonds from Subcontractors and suppliers on the project from which Contractor has required retainages.

E. 5.1.3 The retainage held by Owner shall be included in and paid to the Contractor as part of the final payment of the Contract Price. The Owner shall pay to Contractor interest at the rate of two-thirds of one percent per month on the final payment due Contractor, interest to commence forty five (45) Days after the date which Owner receives Contractor's final approved application for payment and Work under the Contract has been completed and accepted and to run until the date when final payment is tendered to Contractor. The Contractor shall notify Owner in writing when the Contractor considers the Work complete and deliver to Owner its final application for payment and Owner shall, within thirty (30) Days after receiving the written notice and the application for payment, either accept the Work or notify the Contractor of Work yet to be performed on the Contract. If Owner does not within the time allowed notify the Contractor of Work yet to be performed to fulfill contractual obligations, the interest provided by this subsection shall commence to run forty five (45) Days after the end of the 30-Day period.

E.5.1.4 Owner will reduce the amount of the retainage if the Contractor notifies the Owner that the Contractor has deposited in an escrow account with a bank or trust company, in a manner authorized by the Owner, bonds and securities of equal value of a kind approved by the Owner and such bonds and securities have in fact been deposited in accordance with Applicable Laws.

E.5.1.5 Contractor agrees that if Contractor elects to reserve a retainage from any progress payment due to any Subcontractor or supplier, such retainage shall not exceed five percent of the payment, and such retainage withheld from Subcontractors and suppliers shall be subject to the same terms and conditions stated in Subsection E.5 as apply to Owner's retainage from any progress payment due to Contractor.

E.6 FINAL PAYMENT

E.6.1 Upon completion of all the Work under this Contract, the Contractor shall notify the Owner, in writing, that Contractor has completed Contractor's obligations under the Contract and shall prepare its application requesting final payment. Upon receipt

of such notice and application for payment, the Owner will inspect the Work, and, if acceptable, submit to Contractor a recommendation as to acceptance of the completed Work and the final estimate of the amount due the Contractor. If the Work is not acceptable, Owner will notify Contractor within fifteen (15) Days of Contractor's request for final payment. Upon approval of this final application for payment by the Owner and compliance by the Contractor with provisions in Section K, and Contractor's satisfaction of other provisions of the Contract Documents as may be applicable, the Owner shall pay to the Contractor all monies due under the provisions of these Contract Documents.

- E.6.2 Neither final payment nor any remaining retained percentage shall become due until the Contractor submits to the Owner (1) a certificate evidencing that insurance required by the Contract Documents to remain in force after final payment is currently in effect and will not be canceled or allowed to expire until at least thirty (30) Days' prior written notice has been given to the Owner, (2) a written statement that the Contractor knows of no substantial reason that the insurance will not be renewable to cover the period required by the Contract Documents, (3) consent of surety, if any, to final payment and (4), if required by the Owner, other data establishing payment or satisfaction of obligations, such as receipts, releases and waivers of liens, claims, security interests or encumbrances arising out of the Contract, to the extent and in such form as may be designated by the Owner. If a Subcontractor refuses to furnish a release or waiver required by the Owner, the Contractor may furnish a bond satisfactory to the Owner to indemnify the Owner against such lien. If such lien remains unsatisfied after payments are made, the Contractor shall refund to the Owner all money that the Owner may be compelled to pay in discharging such lien, including all costs and reasonable attorneys' fees.
- E.6.3 Acceptance of final payment by the Contractor, a Subcontractor or material supplier shall constitute a waiver of claims by that payee except those previously made in writing and identified by that payee as unsettled at the time of final application for payment.
- E.6.4 Contractor agrees to submit its final payment application within ninety (90) Days after Substantial Completion, unless written extension is granted by Owner. Contractor shall not delay final payment application for any reason, including without limitation nonpayment of Subcontractors, suppliers, manufacturers or others not a party to this Contract, or lack of resolution of a dispute with Owner or any other person of matters arising out of or relating to the Contract. If Contractor fails to submit its final payment application within ninety (90) Days after Substantial Completion, and Contractor has not obtained written extension by Owner, all requests or Claims for additional costs or an extension of Contract Time shall be waived.

SECTION F JOB SITE CONDITIONS

F.1 USE OF PREMISES

Contractor shall confine equipment, storage of materials and operation of Work to the limits indicated by Contract Documents, Applicable Laws, permits or directions of the Owner. Contractor shall follow the Owner's instructions regarding use of premises, if any.

F.2 PROTECTION OF WORKERS, PROPERTY AND THE PUBLIC

F.2.1 Contractor shall maintain continuous and adequate protection of all of the Work from damage and shall protect the Owner, workers and property from injury or loss arising in connection with this Contract. Contractor shall remedy acceptably to the Owner any damage, injury, or loss, except such as may be directly due to errors in the Contract Documents or caused by authorized representatives or personnel of the Owner.

Contractor shall adequately protect adjacent property as provided by law and the Contract Documents.

- F.2.2 Contractor shall take all necessary precautions for the safety of all personnel on the job site or otherwise engaged in the undertaking of the Work and shall comply with the Contract Documents, best practices and all applicable provisions of federal, state and municipal safety laws and building and fire codes to prevent accidents or injury to persons on, about or adjacent to the premises where the Work is being performed. Contractor shall erect and properly maintain at all times, as required by the conditions and progress of the Work, all necessary safeguards for protection of workers and the public against any hazards created by construction. Contractor shall designate a responsible employee or associate on the Work site, whose duty shall be the prevention of accidents. The name and position of the person designated shall be reported to the Owner. The Owner has no responsibility for Work site safety. Work site safety shall be the responsibility of the Contractor.
- F.2.3 Contractor shall not enter upon private property without first obtaining permission from the property owner or its duly authorized representative. Contractor shall be responsible for the preservation of all public and private property along and adjacent to the Work contemplated under the Contract and shall use every precaution necessary to prevent damage thereto. In the event the Contractor damages any property, the Contractor shall at once notify the property owner and make, or arrange to make, full restitution. Contractor shall, immediately and in writing, report to the Owner, all pertinent facts relating to such property damage and the ultimate disposition of the claim for damage.
- F.2.4 Contractor shall be responsible for protection of adjacent work areas including impacts brought about by activities, equipment, labor, utilities, vehicles and materials on the site.
- F.2.5 Contractor shall at all times direct its activities in such a manner as to minimize adverse effects on the environment. Handling of all materials shall be conducted so no release will occur that may pollute or become hazardous.
- F.2.6 In an emergency affecting the safety of life or limb or of the Work or of adjoining property, the Contractor, without special instruction or authorization from the Owner, shall act reasonably to prevent threatened loss or injury, and shall so act, without appeal, if instructed by the Owner. Any compensation claimed by the Contractor on account of emergency work shall be determined in accordance with section D.

F.3 CUTTING AND PATCHING

- F.3.1 Contractor shall be responsible for coordinating all cutting, fitting, or patching of the Work to make its several parts come together properly and fit to receive or be received by work of other contractors or Subcontractors shown upon, or reasonably implied by, the Contract Documents.
- F.3.2 Contractor shall be responsible for restoring all cut, fitted, or patched surfaces to an original condition; provided, however, that if a different condition is specified in the Contract Documents, then Contractor shall be responsible for restoring such surfaces to the condition specified in the Contract Documents.

F.4 CLEANING UP

From time to time as may be prudent or ordered by the Owner and, in any event, immediately after completion of the Work, the Contractor shall, at its own expense, clean up and remove all refuse and unused materials of any kind resulting from the Work. If Contractor fails to do so within twenty-four hours after notification by the Owner

the work may be done by others and the cost charged to the Contractor and deducted from payment due the Contractor.

F.5 ENVIRONMENTAL CONTAMINATION

F.5.1. Contractor shall be held responsible for and shall indemnify, defend (with counsel of Owner's choice), and hold harmless Owner from and against any costs, expenses, damages, claims, and causes of action, (including attorney fees), or any of them, resulting from all spills, releases, discharges, leaks and disposal of environmental pollution, including storage, transportation, and handling during the performance of the Work or Contractor's obligations under the Contract which occur as a result of, or are contributed by, the negligence or actions of Contractor or its personnel, agents, or Subcontractors or any failure to perform in accordance with the Contract Documents (except to the extent otherwise void under ORS 30.140). Nothing in this section F.5.1 shall limit Contractor's responsibility for obtaining insurance coverages required under Section G.3 of this Contract, and Contractor shall take no action that would void or impair such coverages.

F.5.1.1 Contractor agrees to promptly dispose of such spills, releases, discharge or leaks to the satisfaction of Owner and regulatory agencies having jurisdiction in a manner that complies with Applicable Laws. Cleanup shall be at no cost to the Owner and shall be performed by properly qualified and, if applicable, licensed personnel.

F.5.1.2 Contractor shall obtain the Owner's written consent prior to bringing onto the Work site any (i) environmental pollutants or (ii) hazardous substances or materials, as the same or reasonably similar terms are used in any Applicable Laws. Notwithstanding such written consent from the Owner, the Contractor, at all times, shall:

- (a) properly handle, use and dispose of all environmental pollutants and hazardous substances or materials brought onto the Work site, in accordance with all Applicable Laws;
- (b) be responsible for any and all spills, releases, discharges, or leaks of (or from) environmental pollutants or hazardous substances or materials which Contractor has brought onto the Work site; and
- (c) promptly clean up and remediate, without cost to the Owner, such spills, releases, discharges, or leaks to the Owner's satisfaction and in compliance with all Applicable Laws.

F.5.2 Contractor shall report all reportable quantity releases, as such releases are defined in Applicable Laws, including but not limited to 40 CFR Part 302, Table 302.4 and in OAR 340-142-0050, to applicable federal, state, and local regulatory and emergency response agencies. Upon discovery, regardless of quantity, Contractor must telephonically report all releases to the Owner. A written follow-up report shall be submitted to Owner within 48 hours of the telephonic report. Such written report shall contain, as a minimum:

- (a) Description of items released (identity, quantity, manifest numbers, and any and all other documentation required by law.)
- (b) Whether amount of items released is EPA/DEQ reportable, and, if so, when reported.
- (c) Exact time and location of release, including a description of the area involved.
- (d) Containment procedures initiated.

(e) Summary of communications about the release between Contractor and members of the press or State, local or federal officials other than Owner.

(f) Description of cleanup procedures employed or to be employed at the site, including disposal location of spill residue.

(g) Personal injuries, if any, resulting from, or aggravated by, the release.

F.6 ENVIRONMENTAL CLEAN-UP

F.6.1 Unless disposition of environmental pollution is specifically a part of this Contract, or was caused by the Contractor (reference F.5 Environmental Contamination), Contractor shall immediately notify Owner of any hazardous substance(s) which Contractor discovers or encounters during performance of the Work required by this Contract. "Hazardous substance(s)" means any hazardous, toxic and radioactive materials and those substances defined as "hazardous substances," "hazardous materials," "hazardous wastes," "toxic substances," or other similar designations in any federal, state, or local law, regulation, or ordinance, including without limitation asbestos, polychlorinated biphenyl (PCB), or petroleum, and any substances, materials or wastes regulated by 40 CFR, Part 261 and defined as hazardous in 40 CFR S 261.3. In addition to notifying Owner of any hazardous substance(s) discovered or encountered, Contractor shall immediately cease working in any particular area of the project where a hazardous substance(s) has been discovered or encountered if continued work in such area would present a risk or danger to the health or well being of Contractor's or any Subcontractor's work force, property or the environment.

F.6.2 Upon being notified by Contractor of the presence of hazardous substance(s) on the project site, Owner shall arrange for the proper disposition of such hazardous substance(s).

F.7 FORCE MAJEURE

A party to this Contract shall not be held responsible for delay or default due to Force Majeure acts, events or occurrences unless they could have been avoided by the exercise of reasonable care, prudence, foresight, and diligence by that party. The Owner may terminate this Contract upon written notice after determining that delay or default caused by Force Majeure acts, events or occurrences will reasonably prevent successful performance of the Contract.

SECTION G INDEMNITY, BONDING, AND INSURANCE

G.1 RESPONSIBILITY FOR DAMAGES / INDEMNITY

G.1.1 Contractor shall be responsible for all damage to property, injury to persons, and loss, expense, inconvenience, and delay that may be caused by, or result from, the carrying out of the Work to be done under this Contract, or from any act, omission or neglect of the Contractor, its Subcontractors, employees, guests, visitors, invitees and agents.

G.1.2 To the fullest extent permitted by law, Contractor shall indemnify, defend (with counsel approved by Owner) and hold harmless the Owner, Architect/Engineer, Architect/Engineer's consultants, and their respective officers, directors, agents, employees, partners, members, stockholders and affiliated companies (collectively "Indemnitees") from and against all liabilities, damages, losses, claims, expenses (including reasonable attorney fees), demands and actions of any nature whatsoever which arise out of, result from or are related to, (a) any damage, injury, loss, expense, inconvenience or delay described in this Section G.1., (b) any accident or occurrence which happens or is alleged to have happened in or about the

project site or any place where the Work is being performed, or in the vicinity of either, at any time prior to the time the Work is fully completed in all respects, (c) any failure of the Contractor to observe or perform any duty or obligation under the Contract Documents which is to be observed or performed by the Contractor, or any breach of any agreement, representation or warranty of the Contractor contained in the Contract Documents or in any subcontract, (d) the negligent acts or omissions of the Contractor, a Subcontractor or anyone directly or indirectly employed by them or any one of them or anyone for whose acts they may be liable, regardless of whether or not such claim, damage, loss or expense is caused in part by a party indemnified hereunder (except to the extent otherwise void under ORS 30.140), and (e) any lien filed upon the project or bond claim in connection with the Work. Such obligation shall not be construed to negate, abridge, or reduce other rights or obligations of indemnity which would otherwise exist as to a party or person described in this Section G.1.2.

G.1.3 In claims against any person or entity indemnified under Section G.1.2 by an employee of the Contractor, a Subcontractor, anyone directly or indirectly employed by them or anyone for whose acts they may be liable, the indemnification obligation under Section G.1.2 shall not be limited by a limitation on amount or type of damages, compensation or benefits payable by or for the Contractor or a Subcontractor under workers' compensation acts, disability benefit acts or other employee benefit acts.

G.2 PERFORMANCE AND PAYMENT SECURITY; PUBLIC WORKS BOND

G.2.1 When the Contract Price is \$100,000 or more (or \$50,000 or more in the case of Contracts for highways, bridges and other transportation projects), the Contractor shall furnish and maintain in effect at all times during the Contract Period a performance bond in a sum equal to the Contract Price and a separate payment bond also in a sum equal to the Contract Price. Contractor shall furnish such bonds even if the Contract Price is less than the above thresholds if otherwise required by the Contract Documents.

G.2.2 Bond forms furnished by the Owner and notarized by awarded Contractor's surety company authorized to do business in Oregon are the only acceptable forms of performance and payment security, unless otherwise specified in the Contract Documents.

G.2.3 Before execution of the Contract the Contractor shall file with the Construction Contractors Board, and maintain in full force and effect, the separate public works bond required by Oregon Laws 2005, Chapter 360, and OAR 839-025-0015, unless otherwise exempt under those provisions. The Contractor shall also include in every subcontract a provision requiring the Subcontractor to have a public works bond filed with the Construction Contractors Board before starting Work, unless otherwise exempt, and shall verify that the Subcontractor has filed a public works bond before permitting any Subcontractor to start Work.

G.3 INSURANCE

G.3.1 Primary Coverage: Insurance carried by Contractor under this Contract shall be the primary coverage. The coverages indicated are minimums unless otherwise specified in the Contract Documents.

G.3.2 Workers' Compensation: All employers, including Contractor, that employ subject workers who work under this Contract in the State of Oregon shall comply with ORS 656.017 and provide the required Workers' Compensation coverage, unless such employers are exempt under ORS 656.126. This shall include

Employer's Liability Insurance with coverage limits of not less than the minimum amount required by statute for each accident. Contractors who perform the Work without the assistance or labor of any employee need not obtain such coverage if the Contractor certifies so in writing. Contractor shall ensure that each of its Subcontractors complies with these requirements. The Contractor shall require proof of such Workers' Compensation coverage by receiving and keeping on file a certificate of insurance from each Subcontractor or anyone else directly employed by either the Contractor or its Subcontractors.

G.3.3 Builder's Risk Insurance:

G.3.3.1 Builder's Risk: During the term of this Contract, for new construction the Contractor shall obtain and keep in effect Builder's Risk insurance on an all risk forms, including earthquake and flood, for an amount equal to the full amount of the Contract, plus any changes in values due to modifications, Change Orders and loss of materials added. Such Builder's Risk shall include, in addition to earthquake and flood, theft, vandalism, mischief, collapse, transit, debris removal, and architect's fees ("soft costs") associated with delay of project due to insured peril. Any deductible shall not exceed \$50,000 for each loss, except the earthquake and flood deductible which shall not exceed 2 percent of each loss or \$50,000, whichever is greater. The deductible shall be paid by Contractor if Contractor is negligent. The policy will include as loss payees Owner, the Contractor and its Subcontractors as their interests may appear.

G.3.3.2 Builder's Risk Installation Floater: For Work other than new construction, Contractor shall obtain and keep in effect during the term of this Contract, a Builder's Risk Installation Floater for coverage of the Contractor's labor, materials and equipment to be used for completion of the Work performed under this Contract. The minimum amount of coverage to be carried shall be equal to the full amount of the Contract. The policy will include as loss payees Owner, the Contractor and its Subcontractors as their interests may appear. Owner may waive this requirement at its sole and absolute discretion.

G.3.3.3 Such insurance shall be maintained until Owner has occupied the facility.

G.3.3.4 A loss insured under the Builder's Risk insurance shall be adjusted by the Owner and made payable to the Owner as loss payee. The Contractor shall pay Subcontractors their just shares of insurance proceeds received by the Contractor, and by appropriate agreements, written where legally required for validity, shall require Subcontractors to make payments to their Sub-subcontractors in similar manner. The Owner shall have power to adjust and settle a loss with insurers.

G.3.4 General Liability Insurance:

G.3.4.1 Commercial General Liability: Upon execution of this Contract, Contractor shall obtain, and keep in effect at Contractor's expense for the term of this Contract, Commercial General Liability Insurance covering bodily injury and property damage in the amount of \$1,000,000 per claim and \$2,000,000 per occurrence in a form satisfactory to Owner. This insurance shall include personal injury liability, products and completed operations, and contractual liability coverage for the indemnities provided under this Contract (to the extent contractual liability coverage for the indemnity is available in the marketplace), and shall be issued on an occurrence basis.

G.3.4.2 Automobile Liability: Contractor shall obtain, at Contractor's expense, and keep in effect during the term of this Contract, Automobile Liability Insurance covering owned, and/or hired vehicles, as applicable. The coverage may be written in combination with the Commercial General Liability Insurance. Contractor shall provide proof of insurance of not less than

\$1,000,000 per claim and \$2,000,000 per occurrence. Contractor and its Subcontractors shall be responsible for ensuring that all non-owned vehicles maintain adequate Automobile Liability insurance while on site.

- G.3.4.3 Owner may adjust the insurance amounts required in Section G.3.4.1 and G.3.4.2 based upon institution specific risk assessments through the issuance of Supplemental General Conditions to this Contract.
- G.3.4.4 "Tail" Coverage: If any of the required liability insurance is arranged on a "claims made" basis, "tail" coverage will be required at the completion of this Contract for a duration of 36 months or the maximum time period available in the marketplace if less than 36 months. Contractor shall furnish certification of "tail" coverage as described or continuous "claims made" liability coverage for 36 months following Final Completion. Continuous "claims made" coverage will be acceptable in lieu of "tail" coverage, provided its retroactive date is on or before the effective date of this Contract. Owner's receipt of the policy endorsement evidencing such coverage shall be a condition precedent to Owner's obligation to make final payment and to Owner's final acceptance of Work or services and related warranty (if any).
- G.3.4.5: Umbrella Liability (if required by Owner through issuance of Supplemental General Conditions): Contractor shall obtain, at Contractor's expense, and keep in effect during the term of this Contract, Umbrella liability Insurance over and above the general liability, automobile liability and workers' compensation coverage if required by Owner in specified limits at time of requirement.
- G.3.4.6 Pollution Liability (if required by Owner through issuance of Supplemental General Conditions): Contractor shall obtain, at Contractor's expense, and keep in effect during the term of this Contract, Pollution liability Insurance in minimum amounts of \$1,000,000, or other amount as indicated in the Supplemental General Conditions, naming Owner as "additional insured," as noted in the "additional insured section below.
- G.3.5 Additional Insured: The general liability insurance coverage, professional liability, umbrella, and pollution liability if required, shall include the Owner as additional insureds but only with respect to the Contractor's activities to be performed under this Contract.
- If Contractor cannot obtain an insurer to name the Owner as additional insureds, Contractor shall obtain at Contractor's expense, and keep in effect during the term of this Contract, Owners and Contractors Protective Liability Insurance, naming the Owner as additional insureds with not less than a \$2,000,000 limit per occurrence. This policy must be kept in effect for 36 months following Final Completion. As evidence of coverage, Contractor shall furnish the actual policy to Owner prior to execution of the Contract.
- G.3.6 Notice of Cancellation or Change: If the Contractor receives a non-renewal or cancellation notice from an insurance carrier affording coverage required herein, or receives notice that coverage no longer complies with the insurance requirements herein, Contractor agrees to notify Owner by fax within five (5) business days with a copy of the non-renewal or cancellation notice, or written specifics as to which coverage is no longer in compliance. When notified by Owner, the Contractor agrees to stop Work pursuant to this Contract, unless all required insurance remains in effect. Any failure to comply with the reporting provisions of this insurance, except for the potential exhaustion of aggregate limits, shall not affect the coverages provided to the Owner and its institutions, divisions, officers, and employees.

Owner shall have the right, but not the obligation, of prohibiting Contractor from entering the Work site until a new certificate(s) of insurance is provided to Owner evidencing the replacement coverage. The Contractor acknowledges and agrees that Owner reserves the right to withhold payment to Contractor until evidence of reinstated or replacement coverage is provided to Owner.

- G.3.7 Certificate(s) of Insurance: As evidence of the insurance coverage required by this Contract, the Contractor shall furnish certificate(s) of insurance to the Owner prior to execution of the Contract. The certificate(s) will specify all of the parties who are additional insureds or loss payees for this contract. Insurance coverage required under this Contract shall be obtained from insurance companies or entities acceptable to the Owner and that are eligible to provide such insurance under Oregon law. Eligible insurers include admitted insurers that have been issued a certificate of authority from the Oregon Department of Consumer and Business Services authorizing them to conduct an insurance business and issue policies of insurance in the state of Oregon, and certain non-admitted surplus lines insurers that satisfy the requirements of applicable Oregon law and which are subject to approval by the Owner. The Contractor shall be financially responsible for all deductibles, self-insured retentions and/or self-insurance included hereunder. Any deductible, self-insured retention and/or self-insurance in excess of \$50,000 shall be subject to approval by the Owner in writing and shall be a condition precedent to the effectiveness of this Contract.

SECTION H SCHEDULE OF WORK

H.1 CONTRACT PERIOD

- H.1.1 Time is of the essence. The Contractor shall at all times carry on the Work diligently, without delay and punctually fulfill all requirements herein. If required by the Contract Documents, Contractor shall commence Work on the site within fifteen (15) Days of Notice to Proceed, unless directed otherwise.
- H.1.2 Unless specifically extended by Change Order, all Work shall be complete by the date contained in the Contract Documents. The Owner shall have the right to accelerate the completion date of the Work, which may require the use of overtime. Such accelerated Work schedule shall be an acceleration in performance of Work under Section D.1.2 (f) and shall be subject to the provisions of Section D.1.
- H.1.3 The Owner shall not waive any rights under the Contract by permitting the Contractor to continue or complete in whole or in part the Work after the date described in Section H.1.2 above.

H.2 SCHEDULE

H.2.1 Contractor shall provide, by or before the pre-construction conference, the initial as-planned schedule for review and acceptance by the Owner. The submitted schedule must illustrate Work by project components, with labor trades, and long lead items broken down by building and/or floor where applicable. If Owner shall so elect, Contractor shall provide the schedule in CPM format showing the graphical network of planned activities, including i) a reasonably detailed list of all activities required to complete the Work; ii) the time and duration that each activity will take to completion; and iii) the dependencies between the activities. Schedules lacking adequate detail, or unreasonably detailed, will be rejected. The schedule shall include the following: Notice to Proceed or the date the Work commences, if no Notice to Proceed is issued by Owner, Substantial Completion, and Final Completion. Schedules shall be updated monthly, unless otherwise required by the Contract Documents, and submitted with the monthly application for payment. Acceptance of the Schedule by the

Owner does not constitute agreement by the Owner as to the Contractor's sequencing, means, methods, or durations. Any positive difference between the Contractor's scheduled completion and the Contract completion date is float owned by the Owner. Owner reserves the right to negotiate the float if it is deemed to be in Owner's best interest to do so. In no case shall the Contractor make a claim for delays if the Work is completed within the Contract Time but after Contractor's scheduled completion. **H.3 PARTIAL OCCUPANCY OR USE**

H.3.1 The Owner may occupy or use any completed or partially completed portion of the Work at any stage, provided such occupancy or use is consented to by public authorities having jurisdiction over the Work. Such partial occupancy or use may commence whether or not the portion is substantially complete, provided the Owner and Contractor have reasonably accepted in writing the responsibilities assigned to each of them for payments, retainage, if any, security, insurance or self-insurance, maintenance, heat, utilities, and damage to the Work, and have agreed in writing concerning the period for correction of the Work and commencement of warranties required by the Contract Documents with respect to such portion of the Work. Approval by the Contractor to partial occupancy or use shall not be unreasonably withheld. Immediately prior to such partial occupancy or use, the Owner and Contractor shall jointly inspect the area to be occupied or portion of the Work to be used in order to determine and record the condition of the Work. Partial occupancy or use of a portion or portions of the Work shall not constitute acceptance of Work not complying with the requirements of the Contract Documents.

SECTION I CORRECTION OF WORK

I.1 CORRECTION OF WORK BEFORE FINAL PAYMENT

The Contractor warrants to the Owner that materials and equipment furnished under the Contract will be of good quality and new unless otherwise required or permitted by the Contract Documents, that the Work will be free from defects, and that the Work will conform to the requirements of the Contract Documents. Work failing to conform to these requirements shall be deemed defective. Contractor shall promptly remove from the premises and replace all defective materials and equipment as determined by the Owner, whether incorporated in the Work or not. Removal and replacement shall be without loss or expense to the Owner, and Contractor shall bear the cost of repairing all Work destroyed or damaged by such removal or replacement. Contractor shall be allowed a period of no longer than thirty (30) Days after Substantial Completion for completion of defective (Punch List) work. At the end of the thirty-day period, or earlier if requested by the Contractor, Owner shall arrange for inspection of the Work by the Architect/Engineer. Should the work not be complete, and all corrections made, the costs for all subsequent reinspections shall be borne by the Contractor. If Contractor fails to complete the Punch List work within the thirty (30) Day period, Owner may perform such work and Contractor shall reimburse Owner all costs of the same within ten (10) Days after demand without affecting Contractor's obligations.

I.2 WARRANTY WORK

I.2.1 Neither the final certificate of payment nor any provision of the Contract Documents shall relieve the Contractor from responsibility for defective Work and, unless a longer period is specified, Contractor shall correct all defects that appear in the Work within a period of one year from the date of issuance of the written notice of Substantial Completion by the Owner except for latent defects which will be remedied by the Contractor at any time they become apparent. The Owner shall give Contractor notice of defects with reasonable promptness. Contractor shall perform such warranty work within a reasonable time after Owner's demand. If Contractor fails to complete the warranty work within such period as Owner

determines reasonable, or at any time in the event of warranty work consisting of emergency repairs, Owner may perform such work and Contractor shall reimburse Owner all costs of the same within ten (10) Days after demand, without affecting Contractor's obligations. The Contractor shall perform the warranty Work by correcting defects within twenty-four (24) hours of notification by Owner, unless otherwise specified in the Contract Documents. Should the Contractor fail to respond within the specified response time, the Owner may, at its option, complete the necessary repairs using another contractor or its own forces. If Owner completes the repairs using Owner's own forces, Contractor shall pay Owner at the rate of one and one-half (1½) times the standard hourly rate of Owner's forces, plus related overhead and any direct non-salary costs. If Owner completes the repairs using another contractor, Contractor shall pay Owner the amount of Owner's direct costs billed by the other contractor for the work, plus the direct salary costs and related overhead and direct non-salary expenses of Owner's forces who are required to monitor that contractor's work. Work performed by Owner using Owner's own forces or those of another contractor shall not affect the Contractor's contractual duties under these provisions, including warranty provisions.

- I.2.2 Nothing in this Section I.2 shall negate guarantees or warranties for periods longer than one year including, without limitation, such guarantees or warranties required by other sections of the Contract Documents for specific installations, materials, processes, equipment or fixtures.
- I.2.3 In addition to Contractor's warranty, manufacturer's warranties shall pass to the Owner and shall not take effect until such portion of the Work covered by the applicable warranty has been accepted in writing by the Owner.
- I.2.4 The one-year period for correction of Work shall be extended with respect to portions of Work performed after Substantial Completion by the period of time between Substantial Completion and the actual performance of the Work, and shall be extended by corrective Work performed by the Contractor pursuant to this Section, as to the Work corrected. The Contractor shall remove from the site portions of the Work which are not in accordance with the requirements of the Contract Documents and are neither corrected by the Contractor nor accepted by the Owner.
- I.2.5 Nothing contained in this Section I.2 shall be construed to establish a period of limitation with respect to other obligations which the Contractor might have under the Contract Documents. Establishment of the period for correction of Work as described in this Section I.2 relates only to the specific obligation of the Contractor to correct the Work, and has no relationship to the time within which the obligation to comply with the Contract Documents may be sought to be enforced, nor to the time within which proceedings may be commenced to establish the Contractor's liability with respect to the Contractor's obligations other than specifically to correct the Work.
- I.2.6 If the Owner prefers to accept Work which is not in accordance with the requirements of the Contract Documents, the Owner may do so instead of requiring its removal and correction, in which case the Contract Price will be reduced as appropriate and equitable. Such adjustment shall be effected whether or not final payment has been made.

SECTION J SUSPENSION AND/OR TERMINATION OF THE WORK

J.1 OWNER'S RIGHT TO SUSPEND THE WORK

J.1.1 The Owner has the authority to suspend portions or all of the Work due to the following causes:

- (a) Failure of the Contractor to correct unsafe conditions;
- (b) Failure of the Contractor to carry out any provision of the Contract;
- (c) Failure of the Contractor to carry out orders;
- (d) Conditions, in the opinion of the Owner, which are unsuitable for performing the Work;
- (e) Time required to investigate differing site conditions;
- (f) Any reason considered to be in the public interest.

J.1.2 The Owner shall notify Contractor and the Contractor's Surety in writing of the effective date and time of the suspension, and Owner shall notify Contractor and Contractor's surety in writing to resume Work.

J.2 CONTRACTOR'S RESPONSIBILITIES

- J.2.1 During the period of the suspension, Contractor is responsible to continue maintenance at the project just as if the Work were in progress. This includes, but is not limited to, protection of completed Work, maintenance of access, protection of stored materials, temporary facilities, and clean-up.
- J.2.2 When the Work is recommenced after the suspension, the Contractor shall replace or renew any Work damaged during the suspension, remove any materials or facilities used as part of temporary maintenance, and complete the Work in every respect as though its prosecution had been continuous and without suspension.

J.3 COMPENSATION FOR SUSPENSION

- J.3.1 Depending on the reason for suspension of the Work, the Contractor or the Owner may be due compensation by the other party. If the suspension was required due to acts or omissions of Contractor, the Owner may assess the Contractor actual costs of the suspension in terms of administration, remedial work by the Owner's forces or another contractor to correct the problem associated with the suspension, rent of temporary facilities, and other actual costs related to the suspension. If the suspension was caused by acts or omissions of the Owner, the Contractor may be due compensation which shall be defined using Section D, Changes in Work. If the suspension was required through no fault of the Contractor or the Owner, neither party shall owe the other for the impact.

J.4 OWNER'S RIGHT TO TERMINATE CONTRACT

- J.4.1 The Owner may, without prejudice to any other right or remedy, and after giving Contractor seven (7) Days' written notice and an opportunity to cure, terminate the Contract in whole or in part under the following conditions:
 - (a) If Contractor should, voluntarily or involuntarily, seek protection under the United States Bankruptcy Code and Contractor as debtor-in-possession or the Trustee for the estate fails to assume the Contract within a reasonable time;
 - (b) If Contractor should make a general assignment for the benefit of Contractor's creditors;
 - (c) If a receiver should be appointed on account of Contractor's insolvency;
 - (d) If Contractor should repeatedly refuse or fail to supply an adequate number of skilled workers or proper materials to carry on the Work as required by the Contract Documents, or otherwise fail to perform the Work in a timely manner;

- (e) If Contractor should repeatedly fail to make prompt payment to Subcontractors or for material or labor, or should disregard laws, ordinances or the instructions of the Owner; or
- (f) If Contractor is otherwise in breach of any part of the Contract.
- (g) If Contractor is in violation of Applicable Laws, either in the conduct of its business or in its performance of the Work.

J.4.2 At any time that any of the above occurs, Owner may exercise all rights and remedies available to Owner at law or in equity, and, in addition, Owner may take possession of the premises and of all materials and appliances and finish the Work by whatever method it may deem expedient. In such case, the Contractor shall not be entitled to receive further payment until the Work is completed. If the Owner's cost of finishing the Work exceeds the unpaid balance of the Contract Price, Contractor shall pay the difference to the Owner.

J.5 TERMINATION FOR CONVENIENCE

- J.5.1 Owner may terminate the Contract in whole or in part whenever Owner determines that termination of the Contract is in the best interest of Owner or the public.
- J.5.2 The Owner shall provide the Contractor with seven (7) Days prior written notice of a termination for Owner's or for public convenience. After such notice, the Contractor shall provide the Owner with immediate and peaceful possession of the premises and materials located on and off the premises for which the Contractor received progress payment under Section E. Compensation for Work terminated by the Owner under this provision will be according to Section E. In no circumstance shall Contractor be entitled to lost profits for Work not performed due to termination.

J.6 ACTION UPON TERMINATION

- J.6.1 Upon receiving a notice of termination, and except as directed otherwise by the Owner, Contractor shall immediately cease placing further subcontracts or orders for materials, services, or facilities. In addition, Contractor shall terminate all subcontracts or orders to the extent they relate to the Work terminated and, with the prior written approval of the Owner, settle all outstanding liabilities and termination settlement proposals arising from the termination of subcontracts and orders.
- J.6.2 As directed by the Owner, Contractor shall, upon termination, transfer title and deliver to the Owner all Record Documents, information, and other property that, if the Contract had been completed, would have been required to be furnished to the Owner.
- I.6.3 Upon Owner's notice of termination pursuant to either Section J.4 or J.5, if Owner shall so elect, Contractor shall assign to the Owner such subcontracts and orders as Owner shall specify. In the event Owner elects to take assignment of any such subcontract or order, Contractor shall take such action and shall execute such documents as Owner shall reasonably require for the effectiveness of such assignment and Contractor shall ensure that no contractual arrangement between it and its subcontractors or suppliers of any tier or sub-tier shall prevent such assignment.

SECTION K
CONTRACT CLOSE OUT

K.1 RECORD DOCUMENTS

As a condition of final payment (and subject to the provisions of section E.6), Contractor shall comply with the following: Contractor shall provide Record Documents for the entire project to Owner. Record Documents shall depict the project as constructed and shall reflect each and every change, modification, and deletion made during the construction. Record Documents are part of the Work and shall be provided prior to the Owner's issuance of final payment. Record Documents include all modifications to the Contract Documents, unless otherwise directed, and accurate MWESB Reports.

K.2 OPERATION AND MAINTENANCE MANUALS

As part of the Work, Contractor shall submit two completed operation and maintenance manuals ("O & M Manuals") for review by the Owner prior to submission of any pay request for more than 75% of the Work. Owner's receipt of the O & M Manuals shall be a condition precedent to any payment thereafter due. The O & M Manuals shall contain a complete set of all submittals, all product data as required by the specifications, training information, telephone list and contact information for all consultants, manufacturers, installer and suppliers, manufacturer's printed data, record and shop drawings, schematic diagrams of systems, appropriate equipment indices, warranties and bonds. The Owner shall review and return one O & M Manual for any modifications or adjustments required. Prior to submission of its final pay request, Contractor shall deliver three complete and approved sets of O & M Manuals in paper form and one complete and approved set in electronic form to the Owner and Owner's receipt of the O & M Manuals shall be a condition precedent to Owner's obligation to make final payment.

K.3 COMPLETION NOTICES

K.3.1 Contractor shall provide Owner written notice of both Substantial and Final Completion. The certificate of Substantial Completion shall state the date of Substantial Completion, the responsibilities of the Owner and Contractor for security, maintenance, heat, utilities, damage to the Work and insurance, and the time within which the Contractor shall finish all items on the Punch List accompanying the Certificate. Both completion notices must be signed by the Contractor and the Owner to be valid. The Owner shall provide the final signature on the approved notices. The notices shall take effect on the date they are signed by the Owner.

K.3.2 Substantial Completion of a facility with operating systems (e.g., mechanical, electrical, HVAC) shall be that degree of completion that has provided a minimum of thirty (30) continuous Days of successful, trouble-free operation, which period shall begin after all performance and acceptance testing has been successfully demonstrated to the Owner. All equipment contained in the Work, plus all other components necessary to enable the Owner to operate the facility in the manner that was intended, shall be complete on the Substantial Completion date. The Contractor may request that a Punch List be prepared by the Owner with submission of the request for the Substantial Completion notice.

K.4 TRAINING

As part of the Work, and prior to submission of the final application for payment, the Contractor shall schedule with the Owner training sessions for all equipment and systems as required by the Contract Documents. Contractor shall schedule training sessions at least two weeks in advance of the date of training to allow Owner to provide its personnel with adequate notice. The O & M Manual shall be used as a basis for training. Training shall be a formal session conducted at the Work site, or as required by the Contract Documents,

after the equipment and/or system is completely installed and operational in its normal operating environment.

K.5 EXTRA MATERIALS

As part of the Work, Contractor shall provide spare parts, extra maintenance materials, and other materials or products in the quantities specified in the Contract Documents prior to final payment. Delivery point for extra materials shall be designated by the Owner.

K.6 ENVIRONMENTAL CLEAN-UP

As part of the Final Completion notice, or as a separate written notice submitted with or before the notice of Final Completion, the Contractor shall notify the Owner that all environmental and pollution clean-up, remediation and closure have been completed in accordance with all Applicable Laws and pursuant to the authority of all agencies having jurisdiction, and Contractor shall provide Owner with any and all documentation related to the same, including but not limited to directives, orders, letters, certificates and permits related to or arising from such environmental pollution. The notice shall reaffirm the indemnification given under Section F.5.1 above. Contractor's completion of its obligations under this Section K.6 and Owner's receipt of documents evidencing such completion shall be a condition precedent to Owner's obligation to make final payment.

K.7 CERTIFICATE OF OCCUPANCY

Owner's receipt of an unconditioned certificate of occupancy from the appropriate state and/or local building officials shall be a condition precedent to Owner's obligation to make final payment, except to the extent failure to obtain an unconditional certificate of occupancy is due to the fault or neglect of Owner.

K.8 OTHER CONTRACTOR RESPONSIBILITIES

The Contractor shall be responsible for returning to the Owner all property of Owner issued to Contractor during construction such as keys, security passes, site admittance badges, and all other pertinent items. Upon notice from Owner, Contractor shall be responsible for notifying the appropriate utility companies to transfer utility charges from the Contractor to the Owner. The utility transfer date shall not be before Substantial Completion and may not be until Final Completion, if the Owner does not take beneficial use of the facility and the Contractor's forces continue with the Work.

K.9 SURVIVAL

All warranty and indemnification provisions of this Contract, and all of Contractor's other obligations under this Contract that are not fully performed by the time of Final Completion or termination, shall survive Final Completion or any termination of the Contract.

OREGON UNIVERSITY SYSTEM
STANDARD PUBLIC IMPROVEMENT CONTRACT
PERFORMANCE BOND

Bond No. _____
Solicitation _____
Project Name _____

_____ (Surety #1)	Bond Amount No. 1:	\$ _____
_____ (Surety #2)*	Bond Amount No. 2:*	\$ _____
<i>* If using multiple sureties</i>	Total Penal Sum of Bond:	\$ _____

We, _____ as Principal, and the above identified Surety(ies), authorized to transact surety business in Oregon, as Surety, hereby jointly and severally bind ourselves, our respective heirs, executors, administrators, successors and assigns firmly by these presents to pay unto the State of Oregon, acting by and through the State Board of Higher Education, on behalf of the Oregon University System (OUS), the sum of (Total Penal Sum of Bond) _____
(Provided, that we the Sureties bind ourselves in such sum “jointly and severally” as well as “severally” only for the purpose of allowing a joint action or actions against any or all of us, and for all other purposes each Surety binds itself, jointly and severally with the Principal, for the payment of such sum only as is set forth opposite the name of such Surety), and

WHEREAS, the Principal has entered into a contract with the OUS, the plans, specifications, terms and conditions of which are contained in the above-referenced Solicitation;

WHEREAS, the terms and conditions of the contract, together with applicable plans, standard specifications, special provisions, schedule of performance, and schedule of contract prices, are made a part of this Performance Bond by reference, whether or not attached to the contract (all hereafter called “Contract”); and

WHEREAS, the Principal has agreed to perform the Contract in accordance with the terms, conditions, requirements, plans and specifications, and all authorized modifications of the Contract which increase the amount of the work, the amount of the Contract, or constitute an authorized extension of the time for performance, notice of any such modifications hereby being waived by the Surety:

NOW, THEREFORE, THE CONDITION OF THIS BOND IS SUCH that if the Principal herein shall faithfully and truly observe and comply with the terms, conditions and provisions of the Contract, in all respects, and shall well and truly and fully do and perform all matters and things undertaken by Contractor to be performed under the Contract, upon the terms set forth therein,

and within the time prescribed therein, or as extended as provided in the Contract, with or without notice to the Sureties, and shall indemnify and save harmless the OUS, and _____ (name of institution and any other Owner agency), and members thereof, its officers, employees and agents, against any direct or indirect damages or claim of every kind and description that shall be suffered or claimed to be suffered in connection with or arising out of the performance of the Contract by the Principal or its subcontractors, and shall in all respects perform said contract according to law, then this obligation is to be void; otherwise, it shall remain in full force and effect.

Nonpayment of the bond premium will not invalidate this bond, nor shall the State of Oregon or the OUS, be obligated for the payment of any premiums.

This bond is given and received under authority of ORS Chapters 279C and 351, the provisions of which hereby are incorporated into this bond and made a part hereof.

IN WITNESS WHEREOF, WE HAVE CAUSED THIS INSTRUMENT TO BE EXECUTED AND SEALED BY OUR DULY AUTHORIZED LEGAL REPRESENTATIVES.

Dated this _____ day of _____, 20__.

PRINCIPAL: _____

By _____
Signature

Official Capacity
Attest: _____
Corporation Secretary

SURETY: _____
[Add signatures for each surety if using multiple bonds]

BY ATTORNEY-IN-FACT:
[Power-of-Attorney must accompany each surety bond]

Name

Signature

Address

City State Zip

Phone Fax

OREGON UNIVERSITY SYSTEM

STANDARD PUBLIC IMPROVEMENT CONTRACT

PAYMENT BOND

Bond No. _____
Solicitation _____
Project Name _____

_____ (Surety #1)	Bond Amount No. 1:	\$ _____
_____ (Surety #2)*	Bond Amount No. 2:*	\$ _____
<i>* If using multiple sureties</i>	Total Penal Sum of Bond:	\$ _____

We, _____, as Principal, and the above identified Surety(ies), authorized to transact surety business in Oregon, as Surety, hereby jointly and severally bind ourselves, our respective heirs, executors, administrators, successors and assigns firmly by these presents to pay unto the State of Oregon, acting by and through the State Board of Higher education, on behalf of the Oregon University System (OUS), the sum of (Total Penal Sum of Bond) _____ (Provided, that we the Sureties bind ourselves in such sum "jointly and severally" as well as "severally" only for the purpose of allowing a joint action or actions against any or all of us, and for all other purposes each Surety binds itself, jointly and severally with the Principal, for the payment of such sum only as is set forth opposite the name of such Surety), and

WHEREAS, the Principal has entered into a contract with the OUS, the plans, specifications, terms and conditions of which are contained in above-referenced Solicitation;

WHEREAS, the terms and conditions of the contract, together with applicable plans, standard specifications, special provisions, schedule of performance, and schedule of contract prices, are made a part of this Payment Bond by reference, whether or not attached to the contract (all hereafter called "Contract"); and

WHEREAS, the Principal has agreed to perform the Contract in accordance with the terms, conditions, requirements, plans and specifications, and schedule of contract prices which are set forth in the Contract and any attachments, and all authorized modifications of the Contract which increase the amount of the work, or the cost of the Contract, or constitute authorized extensions of time for performance of the Contract, notice of any such modifications hereby being waived by the Surety:

NOW, THEREFORE, THE CONDITION OF THIS BOND IS SUCH that if the Principal shall faithfully and truly observe and comply with the terms, conditions and provisions of the Contract, in all respects, and shall well and truly and fully do and perform all matters and things by it undertaken to be performed under said Contract and any duly authorized modifications that are made, upon the terms set forth therein, and within the time prescribed therein, or as extended therein as provided in the Contract, with or without notice to the Sureties, and shall indemnify and save harmless the OUS and _____ (name of institution and any other Owner agency), and members thereof, its officers, employees and agents, against any claim for direct or indirect damages of every kind and description that shall be suffered or

claimed to be suffered in connection with or arising out of the performance of the Contract by the Contractor or its subcontractors, and shall promptly pay all persons supplying labor, materials or both to the Principal or its subcontractors for prosecution of the work provided in the Contract; and shall promptly pay all contributions due the State Industrial Accident Fund and the State Unemployment Compensation Fund from the Principal or its subcontractors in connection with the performance of the Contract; and shall pay over to the Oregon Department of Revenue all sums required to be deducted and retained from the wages of employees of the Principal and its subcontractors pursuant to ORS 316.167, and shall permit no lien nor claim to be filed or prosecuted against the State on account of any labor or materials furnished; and shall do all things required of the Principal by the laws of this State, then this obligation shall be void; otherwise, it shall remain in full force and effect.

Nonpayment of the bond premium will not invalidate this bond, nor shall the State of Oregon, or the OUS be obligated for the payment of any premiums.

This bond is given and received under authority of ORS Chapters 279C and 351, the provisions of which hereby are incorporated into this bond and made a part hereof.

IN WITNESS WHEREOF, WE HAVE CAUSED THIS INSTRUMENT TO BE EXECUTED AND SEALED BY OUR DULY AUTHORIZED LEGAL REPRESENTATIVES:

Dated this _____ day of _____, 20__.

PRINCIPAL: _____

By _____
Signature

Official Capacity

Attest: _____
Corporation Secretary

SURETY: _____

[Add signatures for each if using multiple bonds]

BY ATTORNEY-IN-FACT:

[Power-of-Attorney must accompany each bond]

Name

Signature

Address

City State Zip

Phone Fax

Project Requirements Hamersly Library Chiller Replacement

Project Description:

The intent of the project is to replace the existing chiller and cooling tower located at Hamersly Library with a new chiller that will be sized for both the Library and the new Richard Woodcock Education Center (RWEC). The replacement shall be that of a new air-cooled modular chiller of 240 tons capacity as minimal. The existing underground condenser water piping will be re-used for the chilled water piping to the Hamersly Library. The piping will be designed as a primary/secondary pumping system, re-using the existing chilled water pumping to the library with a future chilled water pipe connection provided for the new RWEC Building.

Scope of work:

1. Follow the requirements of the engineered documents entitled, "Hamersly Library Chiller Replacement" created by Fresh Aire Engineering, dated January 21, 2015, including the additional clarifications, as follows:
 - A. Contractor shall conduct their own field investigation of the site of demolition and construction as to what is called out on the engineered drawings for any discrepancies and note these to the Owner.
 - B. Contractor shall be responsible for all plumbing, piping, mechanical work as shown on the engineered drawings and specifications. All electrical, low voltage and control work is not part of this contracted work. This work will be contracted separately by Owner.
 - C. Contractor shall complete all work in a professional manner and up to industry standards.
 - D. Contractor shall be responsible for securing any needed permits and fees associated with the scope of work.
 - E. Contractor shall be responsible for the demolition and disposal of the chiller, cooling tower and associated equipment. The Contractor shall also be responsible for all disposal costs and fees associated with the demolition on the project. Contractor to provide a bid for the cost of demolition and disposal and all associated fees as a deductive alternate on bid form.
 - F. Contractor shall be allowed to re-use Victaulic fittings as needed but shall not reuse gaskets/seals for same.
 - G. Contractor shall furnish all needed equipment, tools and supplies to complete project.
 - H. Contractor shall schedule all work in advance with the Owner.
 - I. The Owner will have a chemical contractor on site to apply cleaning and protective chemicals to the chilled water line between Hamersly and the new chiller prior to any water going through the heat exchangers on the modular chiller system. The chemical contractor shall also observe the methods used by general Contractor and outcome of the cleaning and chemical treatment of the piping system between the chiller and the chilled water piping in the Hamersly building.

- J. All work will be completed in accordance with all Federal, State, and local codes. This would include seismic anchoring and restraints.
- K. Contractor to recycle all materials available in a responsible manner including separation of the materials as needed.
- L. Contractor shall provide as built marked up drawings at the conclusion of the project and one electronic and two printed copies in three ring binders of the submittals, operation and maintenance manuals and warranties for all equipment installed as per specifications.
- M. Contractor shall protect landscape and all plantings that are in work zone.
- N. Normal working hours are Monday through Friday 8:00 AM to 5:00 PM. Contractor to arrange other working hours with Owner prior to start of project.
- O. Substantial completion date is May 1, 2015; final completion May 15, 2015.

Owner's Responsibilities:

- A. Construction of concrete pad and installation of chain link fence
- B. Electrical contract work, including low voltage and controls work.
- C. Piping and equipment cleaning and passivation.
- D. Remove, drain all refrigerant.
- E. Disconnect electrical.

Attachments:

Mechanical Plan and Specifications January 21, 2015

End Scope of Work

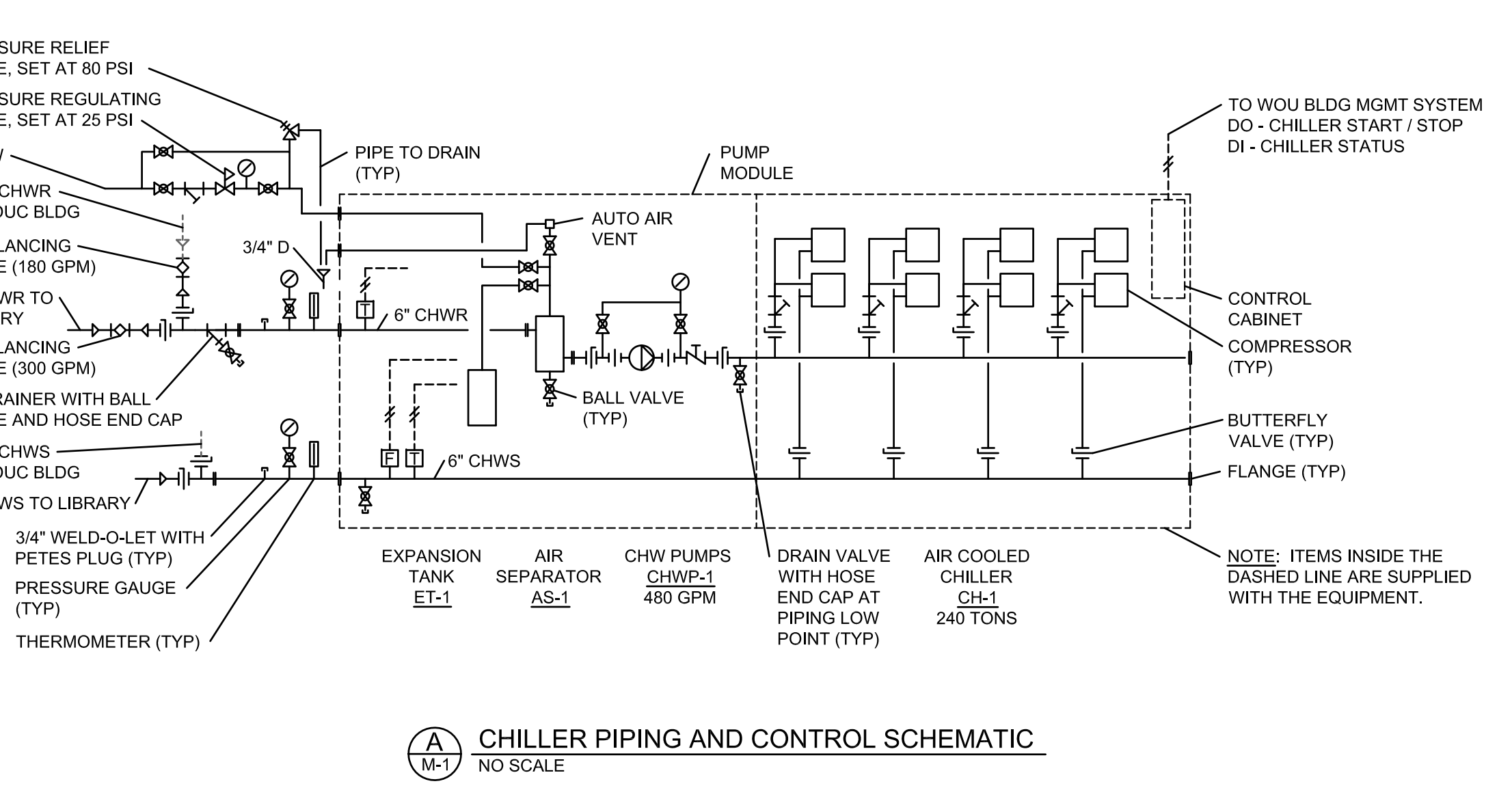
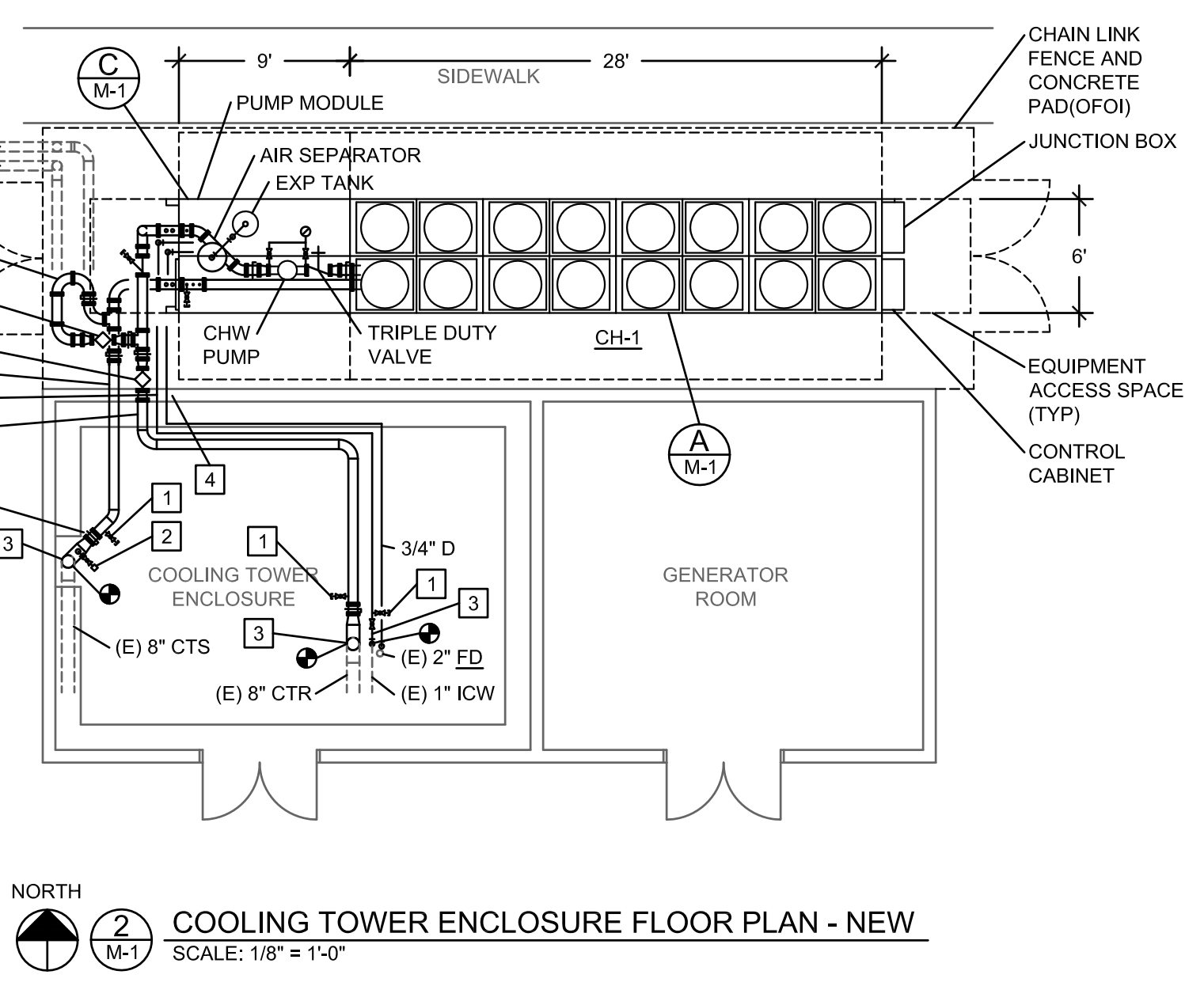
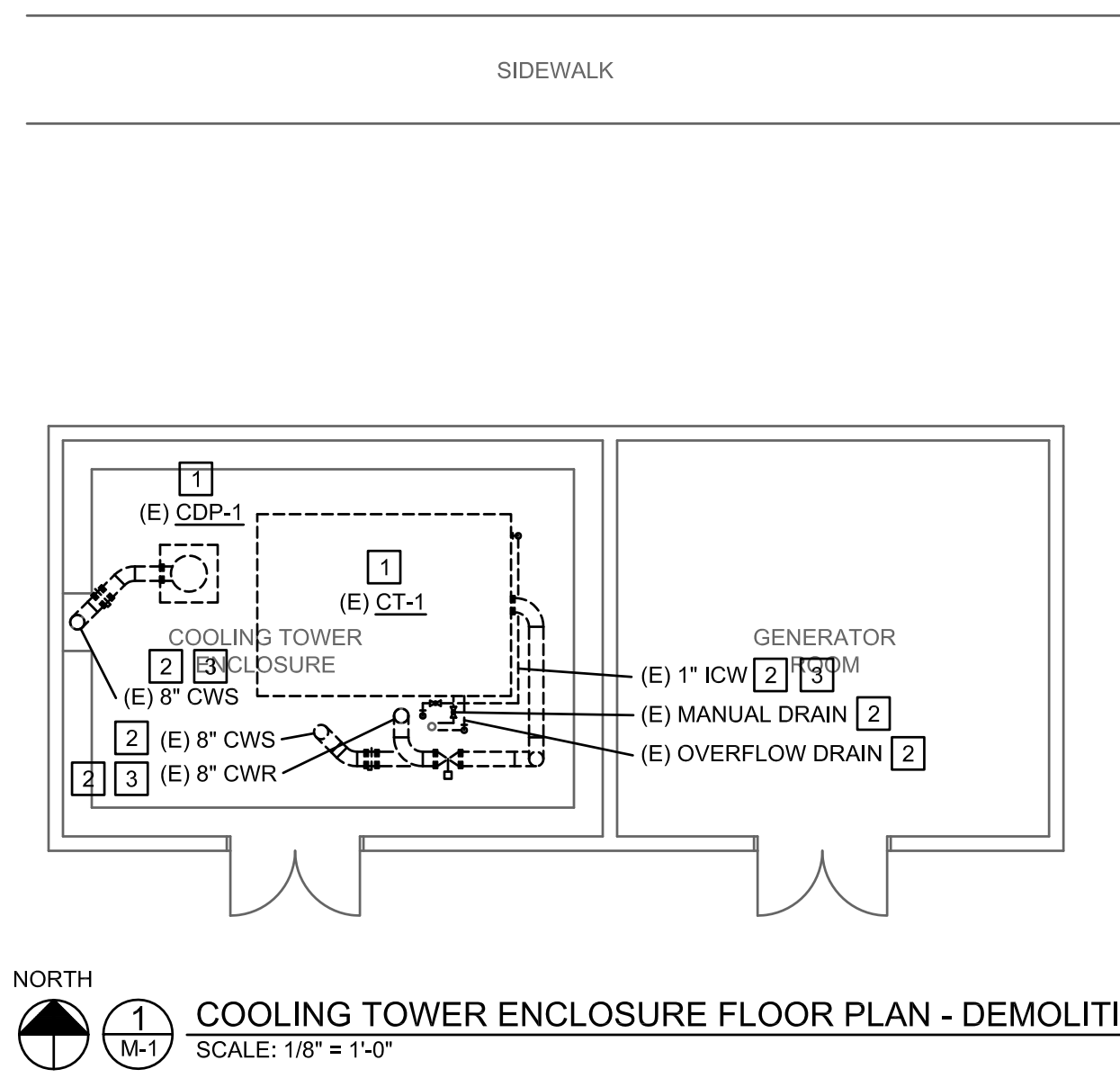

A CHILLER PIPING AND CONTROL SCHEMATIC
NO SCALE

- GENERAL NOTES:**
- CONTRACTOR SHALL FIELD VERIFY EXISTING CONDITIONS AND DIMENSIONS PRIOR TO STARTING CONSTRUCTION.
 - SEE DRAWING M-2 FOR MECHANICAL SPECIFICATIONS. FOR ITEMS NOT LISTED, COMPLY WITH WESTERN OREGON UNIVERSITY SITE STANDARD SPECIFICATIONS.
 - WOU WILL HIRE CONTRACTORS FOR THE FOLLOWING:
 - PIPING AND EQUIPMENT CLEANING AND PASSIVATION.
 - WATER SYSTEM TESTING AND BALANCING.
 - ALL DEVICES SHALL HAVE ISOLATION VALVES FOR MAINTENANCE.
 - PROVIDE THE FOLLOWING BID ALTERNATES:
 - PROVIDE A BASE BID FOR THE AIRSTACK CHILLER. A BID ALTERNATE CAN BE PROVIDED FOR AN APPROVED EQUAL MANUFACTURER.
 - THE BASE BID SHALL INCLUDE THE DEMOLITION AND REMOVAL OF THE EXISTING CHILLER AND COOLING TOWER. PROVIDE A BID ALTERNATE FOR THE OWNER TO REMOVE THE EXISTING CHILLER AND COOLING TOWER.

- FLOOR PLAN - DEMOLITION KEYED NOTES:** X
- REMOVE EXISTING MECHANICAL EQUIPMENT AS INDICATED.
 - REMOVE EXISTING PIPING, PIPE SUPPORTS AND INSULATION AS INDICATED.
 - REMOVE EXISTING ELECTRIC HEAT TRACING AND SAVE FOR REINSTALLATION BY THE OWNER.

- FLOOR PLAN - NEW KEYED NOTES:** X
- INSTALL 3/4" DRAIN VALVE WITH HOSE END CONNECTION AND CAP.
 - INSTALL AUTO AIR VENT AND PIPE DISCHARGE TO DRAIN.
 - COORDINATE OWNER INSTALLATION OF ELECTRIC HEAT TRACING BEFORE PIPING IS INSULATED.
 - OWNER WILL SAW CUT PIPE OPENINGS IN CONCRETE BLOCK WALL. COORDINATE WITH OWNER AFTER PIPING IS LAID OUT.

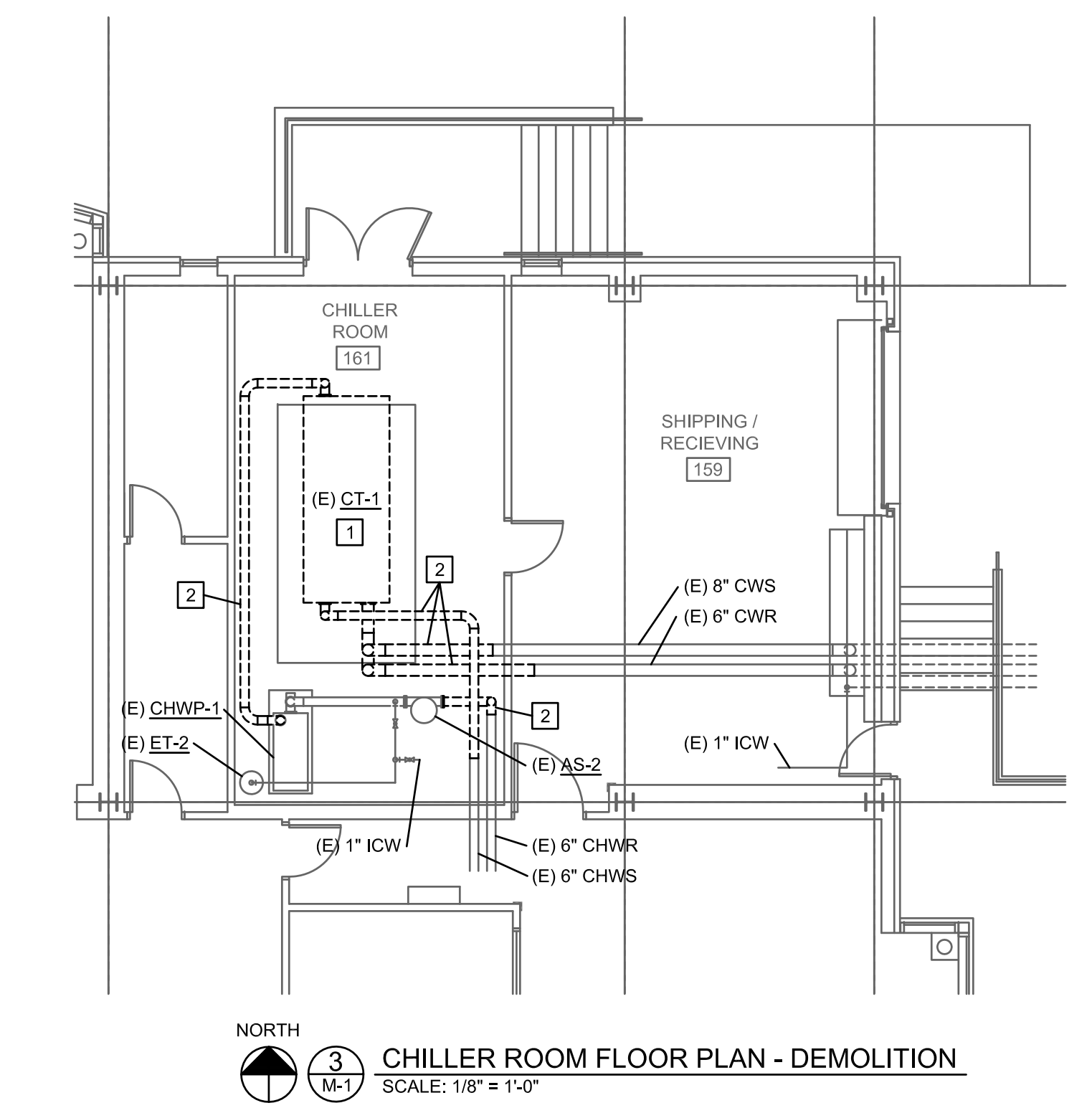

- FLOOR PLAN - DEMOLITION KEYED NOTES:** X
- REMOVE EXISTING MECHANICAL EQUIPMENT AS INDICATED.
 - REMOVE EXISTING PIPING, PIPE SUPPORTS AND INSULATION AS INDICATED.

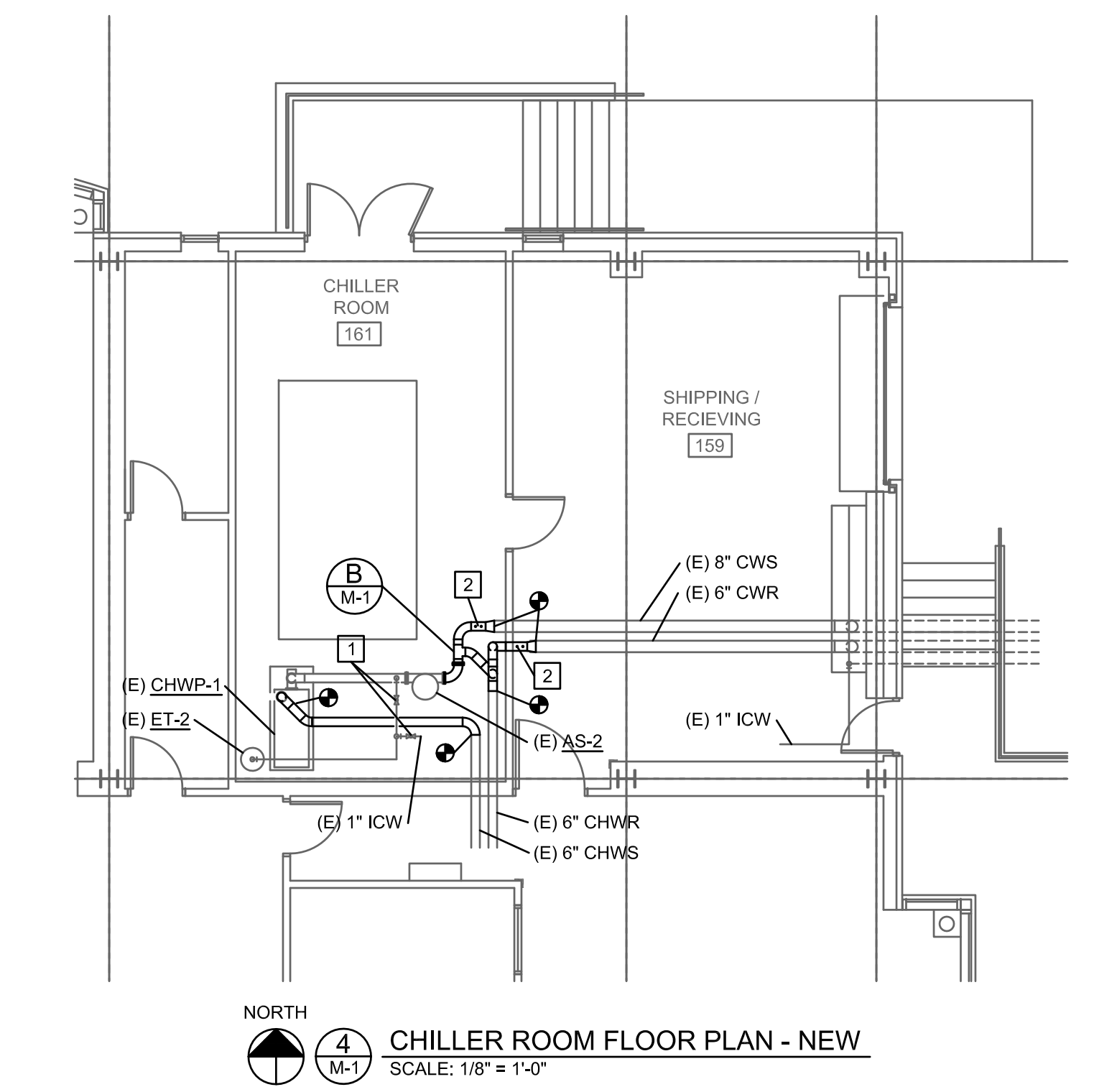

- FLOOR PLAN - NEW KEYED NOTES:** X
- CLOSE EXISTING EXPANSION TANK (AS-2) AND MAKE-UP WATER ISOLATION VALVES.
 - 3/4" THREAD-O-LET FOR TEMPERATURE SENSOR AND PETES PLUG. SEE DETAIL B / M-1.

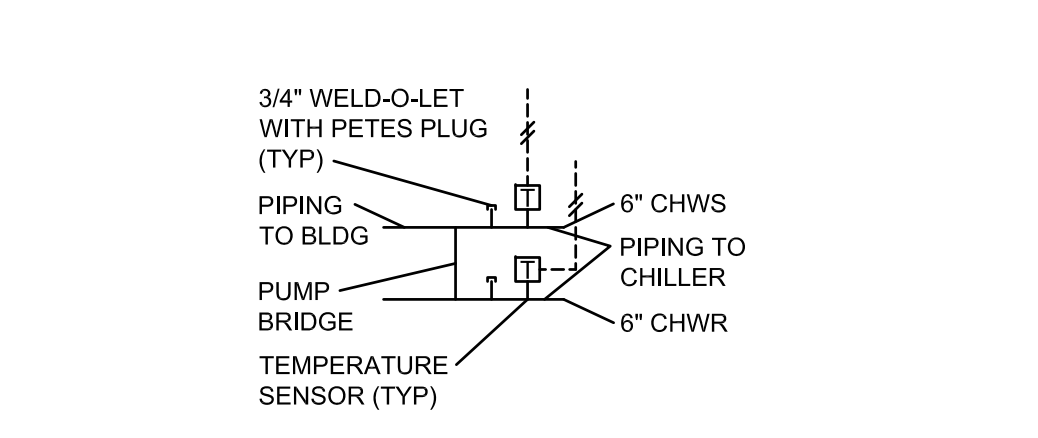

B HAMERSLY PIPING AND CONTROL SCHEMATIC
NO SCALE

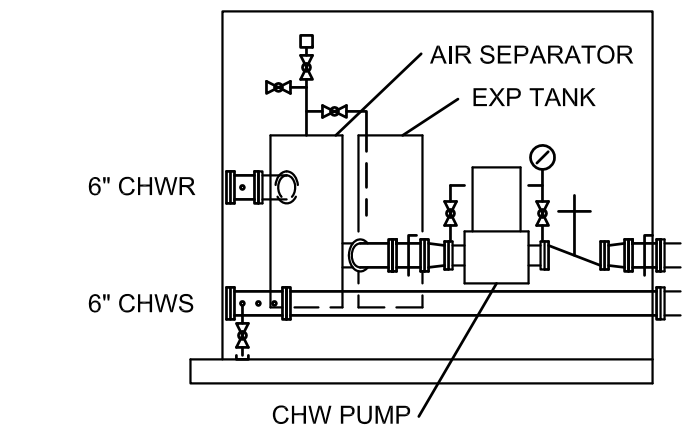

C PUMP MODULE SECTION
NO SCALE



FRESH AIRE ENGINEERING LLC
8245 NW Chaparral Drive - Corvallis, OR - 97330
541-738-8704 - freshaire2002@earthlink.net



WESTERN OREGON UNIVERSITY
HAMERSLY LIBRARY
CHILLER REPLACEMENT
MONMOUTH, OR 97361

ISSUE DATE: 21 JANUARY 2015
PROJECT NO.: 2014-28
REV. *
REV. *
REV. *
REV. *

SHEET TITLE:
SPECIFICATIONS
*
*

MECHANICAL SPECIFICATIONS:

1. PIPING MATERIALS:
 - a. COPPER PIPE AND FITTINGS:
 - i. PIPE: ANSI/ASTM B88, TYPE L, HARD-DRAWN TEMPERED
 - ii. FITTINGS: ANSI B16.18, CAST COPPER, SOLDERED, OR ANSI B16.22, WROUGHT COPPER, SOLDERED
 - iii. JOINTS: SOLDERED
 - b. STEEL PIPE AND FITTINGS, SCHEDULE 40:
 - i. PIPE:
 1. 2" AND UNDER: CARBON STEEL, BLACK, ASTM A53, TYPE B, ERW OR SEAMLESS, SCHEDULE 40, THREADED AND COUPLED
 2. 2-1/2" THROUGH 26": CARBON STEEL, BLACK, ASTM A53, GRADE B, ERW, STANDARD WEIGHT, PLAIN, BEVELED OR MACHINE GROOVED END
 - ii. FITTINGS:
 1. 2" AND UNDER: MALLEABLE IRON, BLACK, ASTM A197, ANSI B16.3, STANDARD WEIGHT
 2. 2-1/2" THROUGH 48": CARBON STEEL, BLACK, ASTM A234, ANSI B16.9, STANDARD WEIGHT OR VICTAULIC
 - iii. JOINTS:
 1. 2" AND UNDER: THREADED, OR WELDED
 2. 2-1/2" THROUGH 48": WELDED OR VICTAULIC

2. PIPING SYSTEMS:
 - a. SUPPORT PIPING IN ACCORDANCE WITH OMSC AND SMACNA SEISMIC RESTRAINT MANUAL: GUIDELINES FOR MECHANICAL SYSTEMS
 - b. THE OWNER WILL HIRE A CONTRACTOR TO CLEAN AND PASSIVATE THE PIPING SYSTEM AND EQUIPMENT
 - c. PIPING SYSTEM CRITERIA:
 - i. CHILLED WATER SUPPLY (CHWS) AND RETURN (CHWR):
 1. 2-1/2" AND SMALLER: COPPER, TYPE L OR STEEL, SCHEDULE 40
 2. 4" AND LARGER: STEEL, SCHEDULE 40
 - ii. DRAIN (D): COPPER, TYPE L
 - iii. INDUSTRIAL COLD WATER (ICW): COPPER, TYPE L

3. PIPING SYSTEM INSULATION:
 - a. INSULATION TYPES:
 - i. EXTRUDED POLYSTYRENE:
 1. ACCEPTABLE MANUFACTURERS: ITW INSULATION SYSTEMS, XPS PIB, OR APPROVED EQUAL
 2. DENSITY (ASTM D1622): 1.6 LBS/FT³
 3. COMPRESSIVE STRENGTH (ASTM D1621): 20 LBS/IN²
 4. K-FACTOR (ASTM C518): 0.259 BTU*IN/HR*FT²*DEG F
 5. WATER ABSORPTION (ASTM C272 / ASTM D2842): 1.0 / 1.0 % BY VOLUME
 6. WATER VAPOR PERMEABILITY (ASTM E95): 1.5 PERM INCH
 7. DIMENSIONAL STABILITY (ASTM D1216): 1.0 % VOLUME CHANGE
 8. SERVICE TEMPERATURE: -297 TO +165 DEG F
 9. SURFACE BURNING CHARACTERISTICS (ASTM E84): 5 /165 UP TO 4" THICKNESS FLAME SPREAD, SMOKE DEVELOPED
 10. COEFFICIENT OF LINEAR THERMAL EXPANSION (ASTM D690): 35 X 10-6 IN/IN*DEG F
 - ii. EXTERIOR PIPE INSULATION: PROVIDE WITH ALUMINUM JACKET, SEALED WATERTIGHT
 1. ALUMINUM JACKET: ASTM B209 (ASTM B209M)
 - b. FORMED ALUMINUM SHEET
 2. FINISH: SMOOTH
 3. JOINING: LONGITUDINAL SLIP JOINTS WITH 2 INCH LAPS
 4. FITTINGS: 0.016 INCH THICK DIE SHAPED FITTING COVERS WITH FACTORY ATTACHED PROTECTIVE LINER
 5. METAL JACKET BANDS: 3/8 INCH WIDE; 0.015 INCH THICK ALUMINUM
 - b. INSULATION CRITERIA:
 - i. CHILLED WATER SUPPLY (CHWS), CHILLED WATER RETURN (CHWR): 1" EXTRUDED POLYSTYRENE
 - ii. DRAIN (D): NO PIPE INSULATION
 - iii. INDUSTRIAL COLD WATER (ICW):
 1. LESS THAN 1-1/2": 1/2" EXTRUDED POLYSTYRENE
 2. 1-1/2" AND GREATER: 1" EXTRUDED POLYSTYRENE

4. VALVES:
 - a. BALL VALVES:
 - i. ACCEPTABLE MANUFACTURERS: APOLLO 70-10X, JOMAR T-100, WATTS B-6000, OR APPROVED EQUAL
 - ii. DESIGN PRESSURE: 400 PSI AT 350 DEG F
 - iii. BODY: BRONZE OR BRASS
 - iv. TRIM: BRONZE BALL
 - v. SEATS: RTE
 - vi. SEALS: TFE
 - vii. PACKING: TFE
 - viii. END CONNECTION: THREADED
 - ix. BODY CONSTRUCTION: TWO PIECE
 - b. BUTTERFLY VALVES:
 - i. ACCEPTABLE MANUFACTURERS: VICTAULIC, VIC-300 MASTERSEAL SERIES 761 OR APPROVED EQUAL
 - ii. DESIGN PRESSURE: 300 PSI AT 250 DEG F
 - iii. BODY: DUCTILE IRON
 - iv. TRIM: DUCTILE IRON DISC
 - v. SEATS: EPDM
 - vi. SEALS: EPDM
 - vii. PACKING: STAINLESS STEEL BEARINGS WITH TFE LINING
 - viii. END CONNECTION: VICTAULIC
 - ix. BODY CONSTRUCTION: WAFER WITH 10 POSITION LEVER HANDLE
 - x. TRIM CONSTRUCTION: 410 STAINLESS STEEL STEM WITH BRASS STEM SEAL CARTRIDGE AND CARBON STEEL STEM RETAINER RING
 - c. BALANCING VALVE:
 - i. ACCEPTABLE MANUFACTURERS: BELL & GOSSETT, CIRCUIT SETTER PLUS, MODEL CB, OR APPROVED EQUAL
 - ii. DESIGN PRESSURE: 100 PSI AT 180 DEG F
 - iii. BODY:
 1. 3 INCHES AND SMALLER: BRONZE
 2. 4 INCHES AND LARGER: CAST IRON
 - iv. TRIM: BRONZE DISC OR BRASS BALL
 - v. SEATS: GLASS AND CARBON-FILLED TFE
 - vi. END CONNECTION:
 1. 3 INCHES AND SMALLER: THREADED
 2. 4 INCHES AND LARGER: CLASS 125 FF

MECHANICAL SPECIFICATIONS (CONT)

4. VALVES (CONT):
 - a. PRESSURE REGULATING VALVE:
 - i. ACCEPTABLE MANUFACTURERS: WATTS REGULATOR, MODEL 25AUB WITH INTEGRAL STRAINER AND PRESSURE GAUGE, OR APPROVED EQUAL
 - ii. BODY: BRONZE
 - iii. SEAT: REPLACEABLE STAINLESS STEEL
 - iv. INTEGRAL STRAINER: STAINLESS STEEL
 - v. DIAPHRAGM: REINFORCED EPDM
 - vi. VALVE DISC: EPDM
 - vii. TEMPERATURE: 33 TO 160 DEG F
 - viii. MAXIMUM WORKING PRESSURE: 300 PSI
 - ix. ADJUSTABLE REDUCED PRESSURE RANGE: 25 TO 75 PSI
 - e. PRESSURE RELIEF VALVE:
 - i. ACCEPTABLE MANUFACTURERS: WATTS REGULATOR, SERIES 530C, CALIBRATED PRESSURE RELIEF VALVE, OR APPROVED EQUAL
 - ii. BODY, BONNET, DISC HOLDER AND SPRING WASHER: BRONZE
 - iii. DISC AND O-RING: BUNA-N (NITRILE)
 - iv. ADJUSTABLE SPRING: STAINLESS STEEL
 - v. MAXIMUM TEMPERATURE: 180 DEG F
 - vi. MAXIMUM WORKING PRESSURE: 300 PSI
 - vii. ADJUSTABLE RANGE: 50 TO 175 PSI
 - f. TRIPLE DUTY VALVE:
 - i. ACCEPTABLE MANUFACTURERS:
 1. BELL & GOSSETT, MODEL 3DS
 2. MUELLER, MODEL 721
 - ii. SEALS: TFE
 - iii. PACKING: TFE / GRAPH
 - iiii. END CONNECTION: CLASS 125 FF
 - ix. BODY CONSTRUCTION: STRAIGHT THROUGH PATTERN
 - x. TRIM CONSTRUCTION: INTEGRAL

5. PIPING ACCESSORIES:
 - a. AUTOMATIC AIR VENT:
 - i. ACCEPTABLE MANUFACTURERS:
 1. BELL & GOSSETT, MODEL 87
 2. HOFFMAN, MODEL, MODEL 79
 - ii. MATERIALS: BODY, COVER, INTERNALS: CAST IRON, BRASS, BRONZE OR STAINLESS STEEL
 - iii. DESIGN PRESSURE (MAWP): 150 PSIG
 - iv. DESIGN TEMPERATURE: 250 DEG F
 - v. INLET CONNECTION: 3/4 INCH NPT
 - vi. OUTLET CONNECTION: 1/2 INCH NPT
 - b. PRESSURE GAUGE:
 - i. ACCEPTABLE MANUFACTURERS:
 1. ASHCROFT 1005 SERIES
 2. MARSH, U.S. GAUGE, MARSHALLTOWN, OR APPROVED EQUAL
 - ii. TYPE: BOURDON TUBE
 - iii. WETTED MATERIALS: BRASS
 - iv. CASE MATERIAL: PAINTED STEEL, BLACK
 - v. DIAL COLOR: WHITE WITH BLACK LETTERS
 - vi. CONNECTION: LOWER OR BACK, 1/4 INCH
 - vii. ACCURACY: GRADE B, 3/20 PERCENT
 - viii. DIAL SIZE: 3-1/2 INCH
 - c. PRESSURE AND TEMPERATURE PLUG:
 - i. ACCEPTABLE MANUFACTURERS: PETE'S PLUG, MODEL 710XL OR APPROVED EQUAL
 - ii. BODY AND CAP: BRASS
 - iii. VALVE CORE MATERIAL: NORDEL
 - iv. THREAD SIZE: 1/2 INCH NPT
 - v. LENGTH: 3 INCH FOR INSULATED PIPING
 - d. THERMOMETER:
 - i. ACCEPTABLE MANUFACTURERS:
 1. ASHCROFT 30-ET-60 SERIES
 2. MARSH, U.S. GAUGE, MARSHALLTOWN, OR APPROVED EQUAL
 - ii. DIAL SIZE: 3 INCH DIAMETER, GLASS WINDOW
 - iii. SENSOR TYPE: BIMETAL
 - iv. STEM CONNECTION: 1/2 INCH NPT
 - v. STEM DIAMETER: 1/4 INCH

- e. THERMOWELL:
 - i. ACCEPTABLE MANUFACTURERS: ASHCROFT, MARSH, U.S. GAUGE, MARSHALLTOWN, OR APPROVED EQUAL
 - ii. SERVICE: GENERAL HYDRONIC SYSTEM WITH INSULATED PIPING
 - iii. TYPE: STEPPED SHANK
 - iv. CONNECTION: 3/4 INCH NPT
 - v. MATERIAL: BRASS
 - vi. BORE DIAMETER: 0.260 INCH
- f. Y-STRAINER:
 - i. 2 INCH AND LESS:
 1. ACCEPTABLE MANUFACTURERS: MUELLER 351M, CONBRACO 59, OR APPROVED EQUAL
 2. TYPE: Y-PATTERN
 3. BODY MATERIAL: BRONZE
 4. SCREEN MATERIAL: STAINLESS STEEL
 5. SCREEN MESH OR PERFORATION SIZE: 20 MESH
 6. ANSI PRESSURE CLASS: 200 PSIG AT 150 DEG F
 7. MAXIMUM OPERATING TEMPERATURE: 350 DEG F AT 150 PSIG
 8. END CONNECTION: NPT
 - ii. 2-1/2 TO 12 INCH:
 1. ACCEPTABLE MANUFACTURERS: MUELLER 751, CONBRACO FCI, OR APPROVED EQUAL
 2. TYPE: Y-PATTERN
 3. BODY MATERIAL: CAST IRON
 4. SCREEN MATERIAL: STAINLESS STEEL
 5. SCREEN MESH OR PERFORATION SIZE: 3/64 INCH PERFORATIONS
 6. ANSI PRESSURE CLASS: 200 PSIG AT 150 DEG F
 7. MAXIMUM OPERATING TEMPERATURE: 450 DEG F AT 125 PSIG
 8. END CONNECTION: ANSI 150FF

MECHANICAL SPECIFICATIONS (CONT)

6. MECHANICAL EQUIPMENT:
 - a. AIR-COOLED CHILLER:
 - i. ACCEPTABLE MANUFACTURERS: AIRSTACK. SUBMIT A BID ALTERNATE APPROVED EQUALS.
 - ii. DESCRIPTION: OUTDOOR, PACKAGED AIR-COOLED LIQUID CHILLER WITH (4) 60-TON DUAL COMPRESSOR MODULES AND PRIMARY PUMP MODULE
 - iii. PERFORMANCE:
 1. COOLING: 245 TONS, 490 GPM, 44 DEG F LWT, 56 DEG F EVT, 9.4 FT WPD, 95 DEG F AMBIENT, R-410 A REFRIGERANT, 10.5 SEER AT 100% LOAD, 20,670 LBS OPERATING WEIGHT.
 2. ELECTRICAL: 485 AMPS MCA (PARALLEL FEEDS REQUIRED), 600 AMPS MOCP, 460V/3PH
 3. SOUND DATA: 88 DBA, 5 FEET FROM UNIT AND 1.5 METERS ABOVE THE GROUND
 3. PRIMARY PUMP MODULE: DUAL PRIMARY PUMPS, AIR SEPARATOR, AND EXPANSION TANK. SEE PERFORMANCE CRITERIA LISTED BELOW.
 - iv. GENERAL:
 1. ETL LISTED IN ACCORDANCE WITH UL STANDARD 1995
 2. CSA CERTIFIED IN ACCORDANCE WITH STANDARD C22.2#236
 3. CHILLERS ARE AHRI CERTIFIED
 4. MODULES ARE FACTORY WIRED AND CHARGED WITH REFRIGERANT WITH FACTORY RUN TEST PRIOR TO SHIPMENT FOR AHRI CERTIFICATION OR THIRD PARTY VERIFIED
 - v. CHILLED WATER MAINS:
 1. STEEL, SCHEDULE 40, CUT GROOVED SUPPLY AND RETURN MAINS PROVIDED FOR INTERCONNECTION OF MODULES. ROLLED GROOVE IS NOT ACCEPTABLE.
 2. EACH COMPRESSOR MODULE TO CONTAIN ISOLATION VALVES AND STRAINER.
 - vi. EVAPORATORS:
 1. BRONZE PLATED HEAT EXCHANGERS
 2. CONSTRUCTED OF 316 STAINLESS STEEL
 3. DESIGNED, TESTED AND STAMPED IN ACCORDANCE WITH UL 1995 CODE FOR 650 PSIG WORKING PRESSURE
 - vii. COMPRESSOR:
 1. EACH MODULE TO CONTAIN TWO HERMETIC SCROLL COMPRESSORS IN TANDEM PIPING ARRANGEMENT
 2. COMPRESSORS MOUNTED WITH RUBBER-IN-SHEAR VIBRATION ISOLATORS
 3. EACH SYSTEM SHALL INCLUDE HIGH DISCHARGE PRESSURE AND LOW SUCTION PRESSURE SAFETY CUT-OUTS
 - viii. CONDENSER FANS:
 1. EACH MODULE TO CONTAIN DUAL CONDENSER FANS FOR EACH REFRIGERATION CIRCUIT
 2. FANS SHALL BE MULTI-BLADE, VANE-AXIAL TYPE MADE OF PLASTIC COMPOSITE MATERIAL
 3. FANS SHALL BE DIRECT DRIVE WITH VARIABLE FREQUENCY DRIVES AND MAXIMUM RPM OF 1,150
 - ix. CENTRAL CONTROL SYSTEM:
 1. SCHEDULING OF LEADLAG COMPRESSORS
 2. MONITOR EACH REFRIGERATION SYSTEM FOR THE FOLLOWING:
 - a. DISCHARGE PRESSURE FAULT
 - b. SUCTION PRESSURE FAULT
 - c. COMPRESSOR WINDING TEMPERATURE
 - d. SUCTION TEMPERATURE
 - e. EVAPORATOR LEAVING CHILLED WATER TEMPERATURE
 3. MASTER CONTROLLER POWERED FROM CHILLER SINGLE POINT POWER CONNECTION AND MONITOR THE FOLLOWING SYSTEM PARAMETERS:
 - a. CHILLED WATER ENTERING AND LEAVING WATER TEMPERATURE
 - b. DISCHARGE REFRIGERANT TEMPERATURE
 - c. CHILLED WATER FLOW
 - d. OUT OF TOLERANCE INDICATION CAUSING A "FAULT" INDICATION AND TRANSFERRING THE LOAD REQUIREMENTS TO THE NEXT COMPRESSOR. THE TIME OF THE FAULT SHALL BE RECORDED ALONG WITH THE SYSTEM CONDITIONS FOR DATA RECALL.
 - e. INDIVIDUAL MONITORING OF ENTERING AND LEAVING CHILLED WATER FOR EACH REFRIGERATION SYSTEM TO PROTECT AGAINST FREEZE-UP
 - f. MONITORING ENTERING AND LEAVING CHILLED WATER TEMPERATURES TO DETERMINE SYSTEM LOAD AND COMPRESSOR STAGING. RESPONSE TIMES AND SET POINTS SHALL BE ADJUSTABLE.
 - x. EXTERNAL INPUTS AND OUTPUTS: TO INCLUDE REMOTE START/STOP AND COOLING ALARM OUTPUT
 - xi. EACH REFRIGERATION CIRCUIT SHALL INCLUDE REFRIGERANT SPECIALTIES TO ALLOW OPERATION DOWN TO 40 DEG F AMBIENT
 - xii. CHILLER SHALL HAVE SINGLE POINT POWER CONNECTION WITH PRE-ENGINEERED WIRING FIELD INSTALLATION AND CONNECTION TO FACTORY MOUNTED JUNCTION BOX.
 - xiii. OPTIONAL PUMP MODULE:
 1. PUMP MODULE TO INCLUDE PUMPS, AIR SEPARATOR, AND EXPANSION TANK WITH CAPACITIES AS SCHEDULED BELOW
 2. PUMP MODULE SHALL INCLUDE ALL INTERCONNECTING PIPING AND BE INTEGRAL WITH THE CHILLER SYSTEM
 3. PROVIDE DUAL, IN-LINE CENTRIFUGAL PUMPS WITH STARTERS AND CONTROLS FOR LEADLAG CONTROLS AND STARTING OF STANDBY PUMP UPON LEAD PUMP FAILURE

3. CHILLERS ARE AHRI CERTIFIED
4. MODULES ARE FACTORY WIRED AND CHARGED WITH REFRIGERANT WITH FACTORY RUN TEST PRIOR TO SHIPMENT FOR AHRI CERTIFICATION OR THIRD PARTY VERIFIED
- v. CHILLED WATER MAINS:
 1. STEEL, SCHEDULE 40, CUT GROOVED SUPPLY AND RETURN MAINS PROVIDED FOR INTERCONNECTION OF MODULES. ROLLED GROOVE IS NOT ACCEPTABLE.
 2. EACH COMPRESSOR MODULE TO CONTAIN ISOLATION VALVES AND STRAINER.
 - vi. EVAPORATORS:
 1. BRONZE PLATED HEAT EXCHANGERS
 2. CONSTRUCTED OF 316 STAINLESS STEEL
 3. DESIGNED, TESTED AND STAMPED IN ACCORDANCE WITH UL 1995 CODE FOR 650 PSIG WORKING PRESSURE
 - vii. COMPRESSOR:
 1. EACH MODULE TO CONTAIN TWO HERMETIC SCROLL COMPRESSORS IN TANDEM PIPING ARRANGEMENT
 2. COMPRESSORS MOUNTED WITH RUBBER-IN-SHEAR VIBRATION ISOLATORS
 3. EACH SYSTEM SHALL INCLUDE HIGH DISCHARGE PRESSURE AND LOW SUCTION PRESSURE SAFETY CUT-OUTS
 - viii. CONDENSER FANS:
 1. EACH MODULE TO CONTAIN DUAL CONDENSER FANS FOR EACH REFRIGERATION CIRCUIT
 2. FANS SHALL BE MULTI-BLADE, VANE-AXIAL TYPE MADE OF PLASTIC COMPOSITE MATERIAL
 3. FANS SHALL BE DIRECT DRIVE WITH VARIABLE FREQUENCY DRIVES AND MAXIMUM RPM OF 1,150
 - ix. CENTRAL CONTROL SYSTEM:
 1. SCHEDULING OF LEADLAG COMPRESSORS
 2. MONITOR EACH REFRIGERATION SYSTEM FOR THE FOLLOWING:
 - a. DISCHARGE PRESSURE FAULT
 - b. SUCTION PRESSURE FAULT
 - c. COMPRESSOR WINDING TEMPERATURE
 - d. SUCTION TEMPERATURE
 - e. EVAPORATOR LEAVING CHILLED WATER TEMPERATURE
 3. MASTER CONTROLLER POWERED FROM CHILLER SINGLE POINT POWER CONNECTION AND MONITOR THE FOLLOWING SYSTEM PARAMETERS:
 - a. CHILLED WATER ENTERING AND LEAVING WATER TEMPERATURE
 - b. DISCHARGE REFRIGERANT TEMPERATURE
 - c. CHILLED WATER FLOW
 - d. OUT OF TOLERANCE INDICATION CAUSING A "FAULT" INDICATION AND TRANSFERRING THE LOAD REQUIREMENTS TO THE NEXT COMPRESSOR. THE TIME OF THE FAULT SHALL BE RECORDED ALONG WITH THE SYSTEM CONDITIONS FOR DATA RECALL.
 - e. INDIVIDUAL MONITORING OF ENTERING AND LEAVING CHILLED WATER FOR EACH REFRIGERATION SYSTEM TO PROTECT AGAINST FREEZE-UP
 - f. MONITORING ENTERING AND LEAVING CHILLED WATER TEMPERATURES TO DETERMINE SYSTEM LOAD AND COMPRESSOR STAGING. RESPONSE TIMES AND SET POINTS SHALL BE ADJUSTABLE.
 - x. EXTERNAL INPUTS AND OUTPUTS: TO INCLUDE REMOTE START/STOP AND COOLING ALARM OUTPUT
 - xi. EACH REFRIGERATION CIRCUIT SHALL INCLUDE REFRIGERANT SPECIALTIES TO ALLOW OPERATION DOWN TO 40 DEG F AMBIENT
 - xii. CHILLER SHALL HAVE SINGLE POINT POWER CONNECTION WITH PRE-ENGINEERED WIRING FIELD INSTALLATION AND CONNECTION TO FACTORY MOUNTED JUNCTION BOX.
 - xiii. OPTIONAL PUMP MODULE:
 1. PUMP MODULE TO INCLUDE PUMPS, AIR SEPARATOR, AND EXPANSION TANK WITH CAPACITIES AS SCHEDULED BELOW
 2. PUMP MODULE SHALL INCLUDE ALL INTERCONNECTING PIPING AND BE INTEGRAL WITH THE CHILLER SYSTEM
 3. PROVIDE DUAL, IN-LINE CENTRIFUGAL PUMPS WITH STARTERS AND CONTROLS FOR LEADLAG CONTROLS AND STARTING OF STANDBY PUMP UPON LEAD PUMP FAILURE

3. CHILLERS ARE AHRI CERTIFIED
4. MODULES ARE FACTORY WIRED AND CHARGED WITH REFRIGERANT WITH FACTORY RUN TEST PRIOR TO SHIPMENT FOR AHRI CERTIFICATION OR THIRD PARTY VERIFIED
- v. CHILLED WATER MAINS:
 1. STEEL, SCHEDULE 40, CUT GROOVED SUPPLY AND RETURN MAINS PROVIDED FOR INTERCONNECTION OF MODULES. ROLLED GROOVE IS NOT ACCEPTABLE.
 2. EACH COMPRESSOR MODULE TO CONTAIN ISOLATION VALVES AND STRAINER.
 - vi. EVAPORATORS:
 1. BRONZE PLATED HEAT EXCHANGERS
 2. CONSTRUCTED OF 316 STAINLESS STEEL
 3. DESIGNED, TESTED AND STAMPED IN ACCORDANCE WITH UL 1995 CODE FOR 650 PSIG WORKING PRESSURE
 - vii. COMPRESSOR:
 1. EACH MODULE TO CONTAIN TWO HERMETIC SCROLL COMPRESSORS IN TANDEM PIPING ARRANGEMENT
 2. COMPRESSORS MOUNTED WITH RUBBER-IN-SHEAR VIBRATION ISOLATORS
 3. EACH SYSTEM SHALL INCLUDE HIGH DISCHARGE PRESSURE AND LOW SUCTION PRESSURE SAFETY CUT-OUTS
 - viii. CONDENSER FANS:
 1. EACH MODULE TO CONTAIN DUAL CONDENSER FANS FOR EACH REFRIGERATION CIRCUIT
 2. FANS SHALL BE MULTI-BLADE, VANE-AXIAL TYPE MADE OF PLASTIC COMPOSITE MATERIAL
 3. FANS SHALL BE DIRECT DRIVE WITH VARIABLE FREQUENCY DRIVES AND MAXIMUM RPM OF 1,150
 - ix. CENTRAL CONTROL SYSTEM:
 1. SCHEDULING OF LEADLAG COMPRESSORS
 2. MONITOR EACH REFRIGERATION SYSTEM FOR THE FOLLOWING:
 - a. DISCHARGE PRESSURE FAULT
 - b. SUCTION PRESSURE FAULT
 - c. COMPRESSOR WINDING TEMPERATURE
 - d. SUCTION TEMPERATURE
 - e. EVAPORATOR LEAVING CHILLED WATER TEMPERATURE
 3. MASTER CONTROLLER POWERED FROM CHILLER SINGLE POINT POWER CONNECTION AND MONITOR THE FOLLOWING SYSTEM PARAMETERS:
 - a. CHILLED WATER ENTERING AND LEAVING WATER TEMPERATURE
 - b. DISCHARGE REFRIGERANT TEMPERATURE
 - c. CHILLED WATER FLOW
 - d. OUT OF TOLERANCE INDICATION CAUSING A "FAULT" INDICATION AND TRANSFERRING THE LOAD REQUIREMENTS TO THE NEXT COMPRESSOR. THE TIME OF THE FAULT SHALL BE RECORDED ALONG WITH THE SYSTEM CONDITIONS FOR DATA RECALL.
 - e. INDIVIDUAL MONITORING OF ENTERING AND LEAVING CHILLED WATER FOR EACH REFRIGERATION SYSTEM TO PROTECT AGAINST FREEZE-UP
 - f. MONITORING ENTERING AND LEAVING CHILLED WATER TEMPERATURES TO DETERMINE SYSTEM LOAD AND COMPRESSOR STAGING. RESPONSE TIMES AND SET POINTS SHALL BE ADJUSTABLE.
 - x. EXTERNAL INPUTS AND OUTPUTS: TO INCLUDE REMOTE START/STOP AND COOLING ALARM OUTPUT
 - xi. EACH REFRIGERATION CIRCUIT SHALL INCLUDE REFRIGERANT SPECIALTIES TO ALLOW OPERATION DOWN TO 40 DEG F AMBIENT
 - xii. CHILLER SHALL HAVE SINGLE POINT POWER CONNECTION WITH PRE-ENGINEERED WIRING FIELD INSTALLATION AND CONNECTION TO FACTORY MOUNTED JUNCTION BOX.
 - xiii. OPTIONAL PUMP MODULE:
 1. PUMP MODULE TO INCLUDE PUMPS, AIR SEPARATOR, AND EXPANSION TANK WITH CAPACITIES AS SCHEDULED BELOW
 2. PUMP MODULE SHALL INCLUDE ALL INTERCONNECTING PIPING AND BE INTEGRAL WITH THE CHILLER SYSTEM
 3. PROVIDE DUAL, IN-LINE CENTRIFUGAL PUMPS WITH STARTERS AND CONTROLS FOR LEADLAG CONTROLS AND STARTING OF STANDBY PUMP UPON LEAD PUMP FAILURE

3. CHILLERS ARE AHRI CERTIFIED
4. MODULES ARE FACTORY WIRED AND CHARGED WITH REFRIGERANT WITH FACTORY RUN TEST PRIOR TO SHIPMENT FOR AHRI CERTIFICATION OR THIRD PARTY VERIFIED
- v. CHILLED WATER MAINS:
 1. STEEL, SCHEDULE 40, CUT GROOVED SUPPLY AND RETURN MAINS PROVIDED FOR INTERCONNECTION OF MODULES. ROLLED GROOVE IS NOT ACCEPTABLE.
 2. EACH COMPRESSOR MODULE TO CONTAIN ISOLATION VALVES AND STRAINER.
 - vi. EVAPORATORS:
 1. BRONZE PLATED HEAT EXCHANGERS
 2. CONSTRUCTED OF 316 STAINLESS STEEL
 3. DESIGNED, TESTED AND STAMPED IN ACCORDANCE WITH UL 1995 CODE FOR 650 PSIG WORKING PRESSURE
 - vii. COMPRESSOR:
 1. EACH MODULE TO CONTAIN TWO HERMETIC SCROLL COMPRESSORS IN TANDEM PIPING ARRANGEMENT
 2. COMPRESSORS MOUNTED WITH RUBBER-IN-SHEAR VIBRATION ISOLATORS
 3. EACH SYSTEM SHALL INCLUDE HIGH DISCHARGE PRESSURE AND LOW SUCTION PRESSURE SAFETY CUT-OUTS
 - viii. CONDENSER FANS:
 1. EACH MODULE TO CONTAIN DUAL CONDENSER FANS FOR EACH REFRIGERATION CIRCUIT
 2. FANS SHALL BE MULTI-BLADE, VANE-AXIAL TYPE MADE OF PLASTIC COMPOSITE MATERIAL
 3. FANS SHALL BE DIRECT DRIVE WITH VARIABLE FREQUENCY DRIVES AND MAXIMUM RPM OF 1,150
 - ix. CENTRAL CONTROL SYSTEM:
 1. SCHEDULING OF LEADLAG COMPRESSORS
 2. MONITOR EACH REFRIGERATION SYSTEM FOR THE FOLLOWING:
 - a. DISCHARGE PRESSURE FAULT
 - b. SUCTION PRESSURE FAULT
 - c. COMPRESSOR WINDING TEMPERATURE
 - d. SUCTION TEMPERATURE
 - e. EVAPORATOR LEAVING CHILLED WATER TEMPERATURE
 3. MASTER CONTROLLER POWERED FROM CHILLER SINGLE POINT POWER CONNECTION AND MONITOR THE FOLLOWING SYSTEM PARAMETERS:
 - a. CHILLED WATER ENTERING AND LEAVING WATER TEMPERATURE
 - b. DISCHARGE REFRIGERANT TEMPERATURE
 - c. CHILLED WATER FLOW
 - d. OUT OF TOLERANCE INDICATION CAUSING A "FAULT" INDICATION AND TRANSFERRING THE LOAD REQUIREMENTS TO THE NEXT COMPRESSOR. THE TIME OF THE FAULT SHALL BE RECORDED ALONG WITH THE SYSTEM CONDITIONS FOR DATA RECALL.
 - e. INDIVIDUAL MONITORING OF ENTERING AND LEAVING CHILLED WATER FOR EACH REFRIGERATION SYSTEM TO PROTECT AGAINST FREEZE-UP
 - f. MONITORING ENTERING AND LEAVING CHILLED WATER TEMPERATURES TO DETERMINE SYSTEM LOAD AND COMPRESSOR STAGING. RESPONSE TIMES AND SET POINTS SHALL BE ADJUSTABLE.
 - x. EXTERNAL INPUTS AND OUTPUTS: TO INCLUDE REMOTE START/STOP AND COOLING ALARM OUTPUT
 - xi. EACH REFRIGERATION CIRCUIT SHALL INCLUDE REFRIGERANT SPECIALTIES TO ALLOW OPERATION DOWN TO 40 DEG F AMBIENT
 - xii. CHILLER SHALL HAVE SINGLE POINT POWER CONNECTION WITH PRE-ENGINEERED WIRING FIELD INSTALLATION AND CONNECTION TO FACTORY MOUNTED JUNCTION BOX.
 - xiii. OPTIONAL PUMP MODULE:
 1. PUMP MODULE TO INCLUDE PUMPS, AIR SEPARATOR, AND EXPANSION TANK WITH CAPACITIES AS SCHEDULED BELOW
 2. PUMP MODULE SHALL INCLUDE ALL INTERCONNECTING PIPING AND BE INTEGRAL WITH THE CHILLER SYSTEM
 3. PROVIDE DUAL, IN-LINE CENTRIFUGAL PUMPS WITH STARTERS AND CONTROLS FOR LEADLAG CONTROLS AND STARTING OF STANDBY PUMP UPON LEAD PUMP FAILURE

MECHANICAL SPECIFICATIONS (CONT)

6. MECHANICAL EQUIPMENT (CONT):
 - a. AIR-COOLED CHILLER (CONT):
 - xiv. SAFETIES, CONTROLS AND OPERATION:
 1. THE FOLLOWING CHILLER SAFETY CONTROLS SHALL BE PROVIDED:
 - a. LOW EVAPORATOR REFRIGERANT PRESSURE
 - b. LOSS OF WATER FLOW THROUGH THE EVAPORATOR
 - c. HIGH CONDENSER REFRIGERANT PRESSURE
 - d. HIGH COMPRESSOR MOTOR TEMPERATURE
 - e. LOW SUCTION GAS PRESSURE
 - f. LOW LEAVING EVAPORATOR WATER TEMPERATURE
 2. FAILURE OF CHILLER TO START OR CHILLER SHUTDOWN DUE TO ABOVE SAFETIES SHALL BE ANNUNCIATED BY DISPLAY WITH APPROPRIATE DIAGNOSTIC DESCRIPTION AT THE UNIT CONTROL PANEL IN PLAIN ENGLISH. ALPHANUMERIC CODES ARE NOT ACCEPTABLE.
 3. THE CHILLER SHALL BE FURNISHED WITH A MASTER CONTROLLER AS AN INTEGRAL PORTION OF THE CHILLER CONTROL CIRCUITRY TO PROVIDE THE FOLLOWING FUNCTIONS:
 - a. AUTOMATIC CHILLER SHUTDOWN WHEN LOAD LEVEL DECREASES BELOW THE NORMAL OPERATING REQUIREMENTS OF THE CHILLER. UPON AN INCREASE IN LOAD, THE CHILLER SHALL AUTOMATICALLY RESTART.
 - b. PROVISIONS FOR CONNECTION TO AUTOMATICALLY ENABLE THE CHILLER FROM A REMOTE ENERGY MANAGEMENT SYSTEM.
 - c. THE CONTROL PANEL SHALL PROVIDE ALPHANUMERIC DISPLAY SHOWING ALL SYSTEM PARAMETERS IN ENGLISH LANGUAGE WITH NUMERIC DATA IN ENGLISH UNITS
 4. NORMAL CHILLER OPERATION:
 - a. WHEN CHILLER IS ENABLED, THE FACTORY SUPPLIED MASTER CONTROLLER MODULATES THE CHILLER CAPACITY FROM MINIMUM TO MAXIMUM AS REQUIRED BY THE BUILDING LOAD
 - b. THE CHILLER CONTROL SYSTEM SHALL RESPOND TO ENTERING WATER TEMPERATURE AND WILL HAVE AN INTEGRAL RESET BASED ON ENTERING WATER TEMPERATURE TO PROVIDE FOR EFFICIENT OPERATION AT PART-LOAD CONDITIONS.
 - xv. WARRANTY AND START-UP:
 1. MANUFACTURER'S WARRANTY:
 - a. ENTIRE CHILLER SHALL BE PROVIDED WITH A FULL PARTS-ONLY WARRANTY COVERAGE FOR ONE YEAR, AGAINST DEFECTS IN MATERIAL AND WORKMANSHIP.
 - b. CHILLER COMPRESSORS SHALL BE PROVIDED WITH A FULL PARTS-ONLY WARRANTY FOR FIVE YEARS
 - c. WARRANTY PERIOD SHALL START UPON EQUIPMENT START-UP DATE OR SIX MONTHS AFTER SHIPMENT, WHICHEVER IS EARLIER
 2. START-UP:
 - a. COMPLETE START-UP SUPERVISION PROVIDED BY A FACTORY AUTHORIZED SERVICE ENGINEER
 - b. FACTORY AUTHORIZED SERVICE ENGINEER IS ALSO RESPONSIBLE FOR ASSEMBLY OF CHILLERS CABINETY PACKAGE AND ELECTRICAL BUS BAR SYSTEM
 - c. MANUFACTURER'S REPRESENTATIVE SHALL BE RESPONSIBLE TO PROVIDE A MINIMUM OF 8-HOURS OF OPERATOR TRAINING TO THE OWNER'S DESIGNATED REPRESENTATIVE(S).
 - d. PUMPS:
 - i. ACCEPTABLE MANUFACTURERS: ARMSTRONG, BELL & GOSSETT, PACO, TACO OR APPROVED EQUAL
 - ii. CHILLED WATER PUMP (CHWP-1): BELL & GOSSETT, SERIES 80, MODEL 5 X 5 X 7 IN-LINE PUMP RATED 480 GPM, 25 FT HD, 5 HP, 460V/3PH, CONSTANT SPEED.
 - e. AIR SEPARATORS:
 - i. ACCEPTABLE MANUFACTURERS: AMTROL, BELL & GOSSETT, TACO, WHEATLEY, OR APPROVED EQUAL
 - ii. AIR SEPARATOR (AS-1): BELL & GOSSETT, MODEL IAS, SIZE INDICATED ON THE PLANS
 - d. EXPANSION TANKS:
 - i. ACCEPTABLE MANUFACTURERS: AMTROL, FLEXCON OR APPROVED EQUAL
 - ii. EXPANSION TANK (ET-1): AMTROL, MODEL SX-40V, NON-ASME RATED, 21 GALLONS TANK VOLUME, 11.3 GALLONS ACCEPTANCE VOLUME, 16 INCH DIAMETER, 30 INCHES TALL, 12 PSIG AIR PRESSURE, 90 LBS SHIPPING WEIGHT

2. FAILURE OF CHILLER TO START OR CHILLER SHUTDOWN DUE TO ABOVE SAFETIES SHALL BE ANNUNCIATED BY DISPLAY WITH APPROPRIATE DIAGNOSTIC DESCRIPTION AT THE UNIT CONTROL PANEL IN PLAIN ENGLISH. ALPHANUMERIC CODES ARE NOT ACCEPTABLE.
3. THE CHILLER SHALL BE FURNISHED WITH A MASTER CONTROLLER AS AN INTEGRAL PORTION OF THE CHILLER CONTROL CIRCUITRY TO PROVIDE THE FOLLOWING FUNCTIONS:
 - a. AUTOMATIC CHILLER SHUTDOWN WHEN LOAD LEVEL DECREASES BELOW THE NORMAL OPERATING REQUIREMENTS OF THE CHILLER. UPON AN INCREASE IN LOAD, THE CHILLER SHALL AUTOMATICALLY RESTART.
 - b. PROVISIONS FOR CONNECTION TO AUTOMATICALLY ENABLE THE CHILLER FROM A REMOTE ENERGY MANAGEMENT SYSTEM.
 - c. THE CONTROL PANEL SHALL PROVIDE ALPHANUMERIC DISPLAY SHOWING ALL SYSTEM PARAMETERS IN ENGLISH LANGUAGE WITH NUMERIC DATA IN ENGLISH UNITS
 4. NORMAL CHILLER OPERATION:
 - a. WHEN CHILLER IS ENABLED, THE FACTORY SUPPLIED MASTER CONTROLLER MODULATES THE CHILLER CAPACITY FROM MINIMUM TO MAXIMUM AS REQUIRED BY THE BUILDING LOAD
 - b. THE CHILLER CONTROL SYSTEM SHALL RESPOND TO ENTERING WATER TEMPERATURE AND WILL HAVE AN INTEGRAL RESET BASED ON ENTERING WATER TEMPERATURE TO PROVIDE FOR EFFICIENT OPERATION AT PART-LOAD CONDITIONS.
 - xv. WARRANTY AND START-UP:
 1. MANUFACTURER'S WARRANTY: