



**OREGON STATE UNIVERSITY
REQUEST FOR QUOTE (RFQ)**

		ISSUE DATE:	October 31, 2011
RFQ #	DL157149Q	RFQ DUE DATE:	November 7, 2011, 2 PM
DELIVER TO:		REQUESTED BY / RETURN QUOTE TO:	
DEPARTMENT:	College of Education	NAME:	Debora Lauer
ADDRESS:	Oregon State University	E-MAIL:	Debora.Lauer@oregonstate.edu
CITY, STATE ZIP:	Corvallis, OR 97331	TELEPHONE:	541-737-7343
REQUIRED DELIVERY DATE:	In place by 4/1/12	FAX:	541-737-2170

ITEM	DESCRIPTION	QTY	UNIT	UNIT PRICE	TOTAL PRICE
1	Item Code: Conference Table TB-4	6	EA		
2	Item Code: Credenza TB-5	3	EA		
3	Item Code: Library Shelving SH-1	4	EA		
4	Item Code: Café Chair CH-3	16	EA		
5	Item Code: Lounge Chair CH-4A	9	EA		
6	Item Code : Lounge Chair CH-4B	7	EA		
7	Item Code: Sofa CH-5	2	EA		
8	Item Code: Banquette Seating CH-10	6	EA		
9	Item Code: Sofa CH-11A & B	3	EA		
10	Item Code: Sofa CH-12A & B	3	EA		
11	Item Code: Bench CH-13	2	EA		
12	Item Code : Bench CH-14A & B	2	EA		

BRAND SPECIFIC – NO SUBSTITUTIONS

See Attached for Detailed Specifications

Delivery is f.o.b. destination, prepaid and allowed. Shipping, freight and handling must be included in quoted prices. Additional costs for such are disallowed.

TOTAL

DELIVERY TIME AFTER RECEIPT OF ORDER:

PRICES VALID THROUGH:

SPECIAL INSTRUCTIONS:

1. Unless otherwise specified, all items quoted are to be new, unused and not remanufactured in any way.
2. Brand names are for the purpose of describing and establishing the characteristics desired and are not intended to limit or restrict competition. Quoters may submit quotes for substantially equivalent products unless the RFQ provides that a specific brand is necessary because of compatibility requirements, etc. All such brand substitutions shall be subject to approval by OSU.
3. Quoters must clearly identify all products quoted. Brand name and model or number must be shown.
4. Only documents issued as addenda by OSU serve to change the RFQ in any way.
5. OSU reserves the right to make the award by item, groups of items or entire quote, whichever is in the best interest of OSU.
6. OSU may reject any Quote not in compliance with the RFQ, attachments, and addenda, or if it is in the best interest of OSU.

VENDOR INFORMATION:

COMPANY:

ADDRESS:

CITY, STATE, ZIP:

CONTACT NAME:

E-MAIL:

TELEPHONE:

FAX:

VENDOR SIGNATURE:

By signature below the undersigned certifies that they are authorized to act on behalf of the quoter and will comply with all aspects of the quote herein.

SIGNATURE:

NAME/TITLE:

This procurement is subject to the indicated Oregon State University Standard Terms and Conditions for: Goods Services Purchase Order Construction Software. The indicated terms and conditions may be viewed at <http://pacs.oregonstate.edu/terms-and-conditions>

ITEM 1

OSU Education Hall Interior Renovation Item Specification

Item Code:

CONFERENCE TABLE TB-4

Project: OSU Education Hall Interior Renovation
FFA Project #: 10-98-07

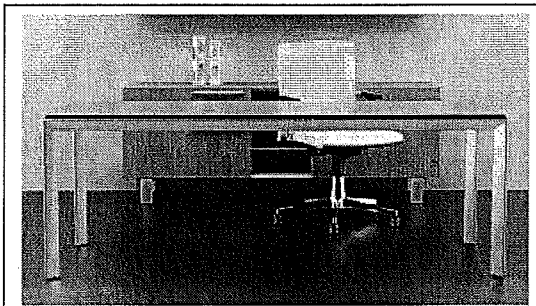

Item Name: Conference Table

Location: Per plan

Unit Quantity: 6 (Vendor to verify quantity)

Description:

Manufacturer: Watson Desking

Model: MCVREC3660YPSM; Miro Conference Table, Rectangle

Dimensions: 60"W x 36"D x 29"H

Construction: Double-refined medium density fiberboard top finished in high pressure commercial grade laminate with chamfered edge. Base constructed from powdercoated 14-gauge triangular steel tube, mitred at the corners. Connection creates a floating effect between base and table top.

Top Surface: Standard Watson Woodgrain Plastic Laminate; FE - Fine Sycamore

Top Surface Edge: Miro Edge; ZE - Clear Stain

Frame/Base Finish: Standard Watson Powdercoat: WA - White Aluminum

Glides: Heavy-duty glides for carpet

Accessories:

Provide (1) Magnetic Cable Channel MACCH26 (vendor to verify height) per table. Finish on cable channel to match table leg finish.

Provide cable management tray under table top for cables reaching from drop-in power unit to magnetic cable channel at leg. Verify placement of cable tray installation with owner in order to best access existing power/data floor box in room.

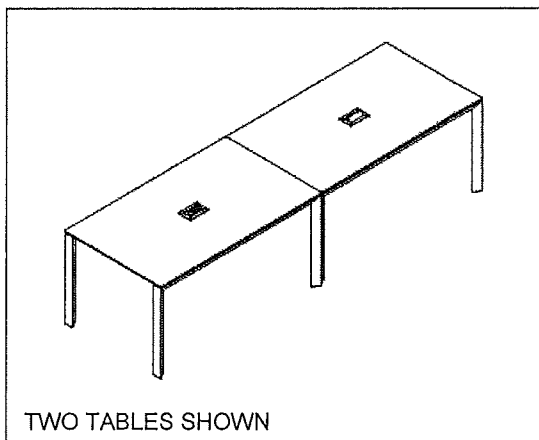

Item Notes:

Provide finish submittals for Architect's review prior to fabrication. See following page 5A for more detailed drawing.

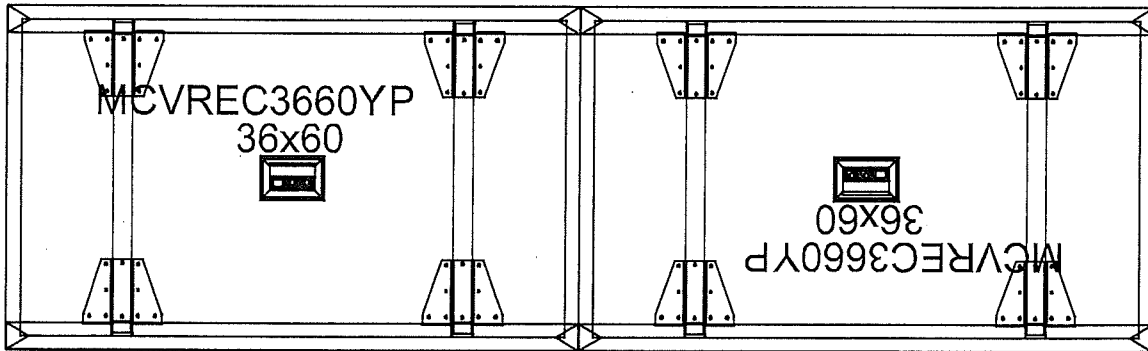
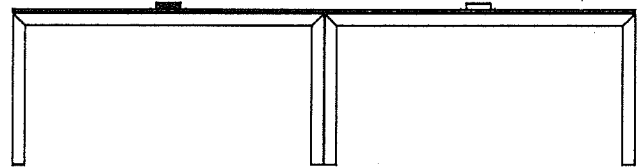
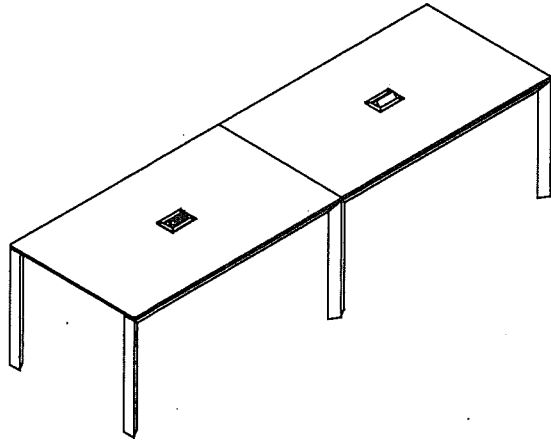

Project Name: OSU - ED HALL

Rep / Dealer: KW

Drawn By / PC: MILLS / JOSHUA MILLS

Date Drawn: 8/23/11

F02

Revision # / Date / By:

Scale : NTS
NOTE: PDF files not to scale

NOTE: Verify all building dimensions on-site prior to purchase or installation of product.

Watson agrees to provide AutoCAD product symbols that are correct. In turn, the agent or customer is responsible for providing accurate building plans, including dimensions, features, and information required for space planning and installation.

THIS MATERIAL SHOULD NOT BE REPRODUCED IN ANY FORM WITHOUT PROPER WRITTEN PERMISSION FROM WATSON.
© 2011 Watson Furniture Group, Inc. All Rights Reserved

watson™

26246 Twelve Trees Lane NW, Poulsbo, Washington 98370 800.426.1202 | www.watsonfurniture.com

ITEM 2

OSU Education Hall Interior Renovation Item Specification

Item Code:

CREDENZA TB-5

Project: OSU Education Hall Interior Renovation
FFA Project #: 10-98-07

Item Name: Credenza

Location: Per plan

Unit Quantity: 3 Sets (Vendor to verify quantity)



Description:

Manufacturer: Watson Desking

Model: (Qty. 2 Each) MS5632030NSLSP; Miro Storage Support, 2-Door, Locking, Miro Pull - Silver

Dimensions: 30"W x 20"D x 28"H

Add:

Model: (Qty. 1 Each) MTREC2060NNSM; Miro Rectangular Surface, no base, Miro Edge

Dimensions: 60"W x 20"D

Top Surfaces: Standard Watson Woodgrain Plastic Laminate; FE - Fine Sycamore

Top Surface Edges: Miro Edge; ZE - Clear Stain

Metal Frame/Base Finish: Standard Watson Powdercoat: WA - White Aluminum

Door Locks: Satin Chrome or similar finish. Verify keying with Owner.

Glides: Heavy-duty glides for carpet

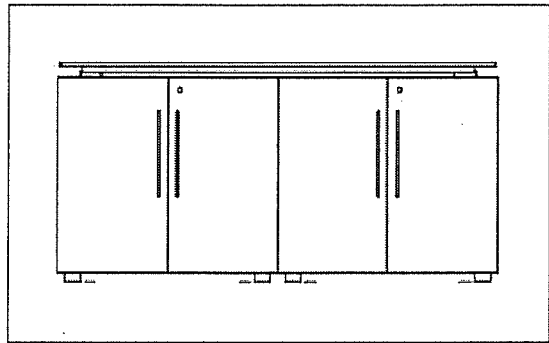

Item Notes:

Provide finish submittals for Architect's review prior to fabrication.
See following page 6A for more detailed drawing.

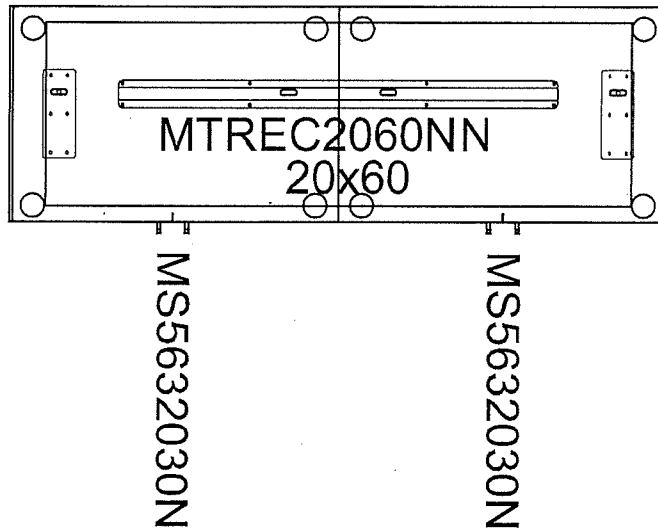
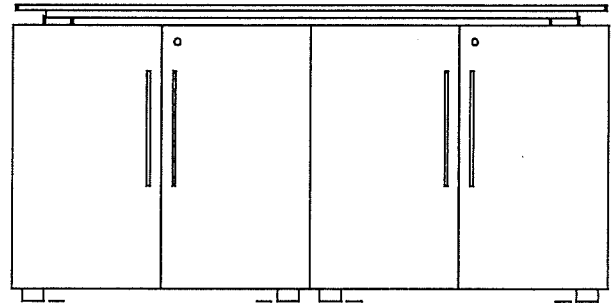
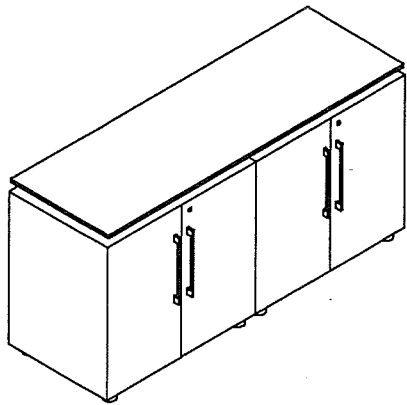

Project Name: OSU - ED HALL

Drawn By / PC: MILLS / JOSHUA MILLS

Rep / Dealer: KW

Date Drawn: 8/23/11

F01

Revision # / Date / By:

Scale: NTS
NOTE: PDF files not to scale

NOTE: Verify all building dimensions on-site prior to purchase or installation of product.

Watson agrees to provide AutoCAD product symbols that are correct. In turn, the agent or customer is responsible for providing accurate building plans, including dimensions, features, and information required for space planning and installation.

THIS MATERIAL SHOULD NOT BE REPRODUCED IN ANY FORM WITHOUT PROPER WRITTEN PERMISSION FROM WATSON.
© 2011 Watson Furniture Group, Inc. All Rights Reserved

watson™

26246 Twelve Trees Lane NW, Poulsbo, Washington 98370 800.426.1202 | www.watsonfurniture.com

ITEM 3

OSU Education Hall Interior Renovation Item Specification

Item Code:

LIBRARY SHELVING SH-1

Project: OSU Education Hall Interior Renovation
FFA Project #: 10-98-07

Item Name: Library Shelving

Location: Per plan

Unit Quantity: 4 (Vendor to verify quantity)

Description:

Manufacturer: Worden

Model: Bookshelf Unit with Glass Doors

Dimensions: 36"W x 12"D x 82"H

Construction:

Case Construction: Sides shall be 1" thick hardwood veneer core plywood with premium maple veneer faces and maple hardwood bands at vertical edges. Matching veneer toe kick base and top panel with maple hardwood bands at exposed edges. A finished maple hardwood rail shall be fastened along the top front edge of the top panel. Finished matching maple veneer back panel. Base shelf shall be 3/4" thick maple hardwood.

Shelf Construction: The case shall be supplied with four adjustable shelves and one fixed mid shelf. The shelves shall be 3/4" thick maple hardwood. Adjustable shelves shall rest on 8mm pins and shall be adjustable on 1-1/4" increments. The fixed mid shelf shall rest on the same pins and shall be permanently fastened to the side panels with metal brackets.

Glass Door Construction: Glass doors shall include a maple hardwood frame with double doweled joints. A 1/4" thick, clear, tempered glass panel shall be set into the frame from the back side and shall be held in place with a black vinyl cleat. A double door lock shall be installed at the mid height of the door and shall engage the fixed mid shelf. Verify keying with Owner. The doors shall be mounted on concealed, knuckle hinges. Wire pulls shall be installed on the case.

Wood Species / Finish: Clear Sealer and Lacquer on Maple

Door Pull Finish: Satin Stainless Steel

Glides: Heavy-duty glides for carpet

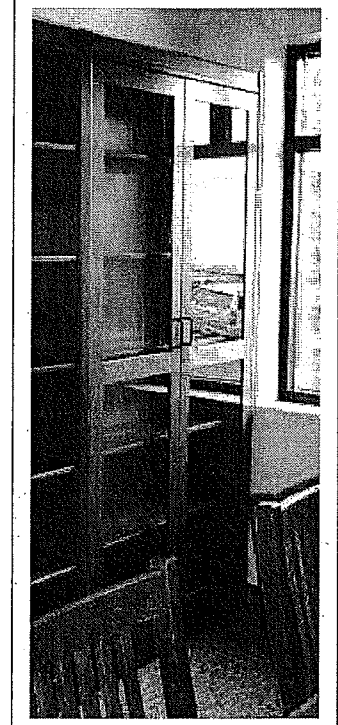

Item Notes:

Provide finish submittals for Architect's review prior to fabrication.

ITEM 4

OSU Education Hall Interior Renovation Item Specification

Item Code:

CAFÉ CHAIR CH-3

Project: OSU Education Hall Interior Renovation
FFA Project #: 10-98-07

Item Name: Café Chair

Location: Per plan

Unit Quantity: 16 (Vendor to verify quantity)

Description:

Manufacturer: Leland International

Model: CES-MP-11-ST; Crepe Side Chair

Dimensions: 19.5"W x 24"D x 32.5"H x 17.75"SH

Shell Wood Species: Maple

Shell Finish: Transparent Wood Finish: Natural Maple 11

Leg Finish: ST - Sterling

Glides: Heavy-duty glides for resilient floors

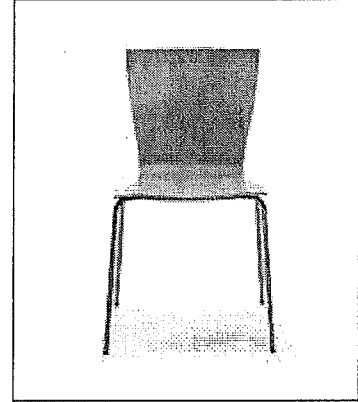

Item Notes:

Provide finish submittals for Architect's review prior to fabrication.

ITEM 5

OSU Education Hall Interior Renovation Item Specification

Item Code:

LOUNGE CHAIR CH-4A

Project: OSU Education Hall Interior Renovation
FFA Project #: 10-98-07

Item Name: Lounge Chair

Location: Per plan

Unit Quantity: 9 (Vendor to verify quantity)

Description:

Manufacturer: HBF – Hickory Business Furniture

Model: Bianco 5095-30; Bianco Lounge Chair

Dimensions: 34.5"W x 31"D x 30.5"H x 18"SH

Base/Leg Finish: Brushed Satin Nickel

Glides/Casters: Heavy-duty glides for carpet

Fabric: (COM)

Manufacturer: Architex

Pattern: Industry

Color: Oak

Width: 54"

Repeat: 6"V, 14.5"H

Content: 81% Polyester, 19% Acrylic

Finish/Backing: Add Nano-Tex with DuraBlock

Durability: Exceeds 50,000 double rubs

Yardage per unit: (Verify)

Installation: Do not railroad fabric

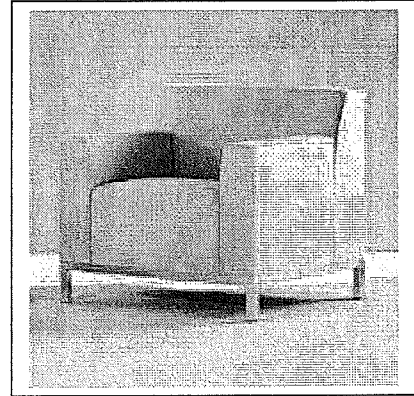

Item Notes:

Provide finish submittals for Architect's review prior to fabrication.

ITEM 6

OSU Education Hall Interior Renovation Item Specification

Item Code:

LOUNGE CHAIR CH-4B

Project: OSU Education Hall Interior Renovation
FFA Project #: 10-98-07

Item Name: Lounge Chair

Location: Per plan

Unit Quantity: 7 (Vendor to verify quantity)

Description:

Manufacturer: HBF – Hickory Business Furniture

Model: Bianco 5095-30; Bianco Lounge Chair

Dimensions: 34.5"W x 31"D x 30.5"H x 18"SH

Base/Leg Finish: Brushed Satin Nickel

Glides/Casters: Heavy-duty glides for carpet

Fabric: (COM)

Manufacturer: Architex

Pattern: Pelle

Color: Bentley

Width: 54"

Repeat: None

Content: 100% Polyurethane

Finish/Backing: 100% Stretch Knit Viscose

Durability: Exceeds 200,000 double rubs

Yardage per unit: (Verify)

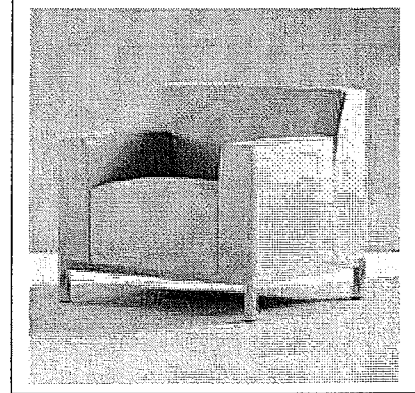

Item Notes:

Provide finish submittals for Architect's review prior to fabrication.

ITEM 7

OSU Education Hall Interior Renovation Item Specification

Item Code:

SOFA CH-5

Project: OSU Education Hall Interior Renovation
FFA Project #: 10-98-07

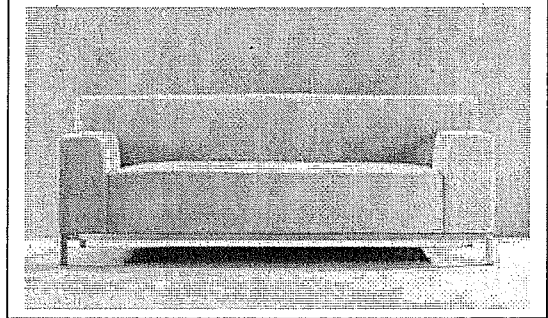

Item Name: Sofa

Location: Per plan

Unit Quantity: 2 (Vendor to verify quantity)

Description:

Manufacturer: HBF – Hickory Business Furniture

Model: Bianco 5096-30; Bianco Sofa

Dimensions: 82"W x 31"D x 30.5"H x 18"SH

Base/Leg Finish: Brushed Satin Nickel

Glides/Casters: Heavy-duty glides for carpet

Fabric: (COM)

Manufacturer: Kravet

Pattern: 29407

Color: 606

Width: 54"

Repeat: None

Content: 100% Polyester

Finish/Backing: Nano-Tex, add DuraBlock

Durability: 100,000 double rubs

Yardage per unit: (Verify)

Item Notes:

Provide finish submittals for Architect's review prior to fabrication.

ITEM 8

OSU Education Hall Interior Renovation Item Specification

Item Code:

BANQUETTE SEATING CH-10

Project: OSU Education Hall Interior Renovation
FFA Project #: 10-98-07

Item Name: Banquette Seating

Location: Per plan

Unit Quantity: 6 (Vendor to verify quantity)

Description:

Manufacturer: Martin Bratrud

Model: Chair 965-01; La Moye Banquette, standard unit, armless

Dimensions: 26"W x 30.5"D x 32"H x 18.5"SH x 20"SD

Construction: Individual straight seat unit. Standard polished chrome legs. High-density foam.

Glides: Heavy-duty glides for resilient floor application

Seat Back Fabric: (COM)

Manufacturer: Sina Pearson Textiles

Pattern: Coffee Berry

Color: 275-92 Dark Roast

Width: 54"

Repeat: 13.3"V, 13.5"H

Content: 70% Polyester, 30% Rayon

Finish/Backing: Crypton

Durability: 75,000 double rubs

Yardage per unit: (Verify)

Installation: Do not railroad fabric

Seat Fabric: (COM)

Manufacturer: Architex

Pattern: Aura

Color: Noble

Width: 54"

Repeat: None

Content: 100% Polyurethane

Finish/Backing: Repel / 100% 4-Way Stretch Knit Polyester

Durability: Exceeds 300,000 double rubs

Yardage per unit: (Verify)

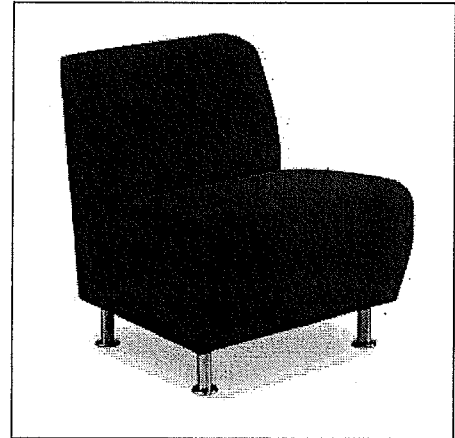

Item Notes:

Provide finish submittals for Architect's review prior to fabrication.

ITEM 9

OSU Education Hall Interior Renovation Item Specification

Item Code:

SOFA CH-11A

Project: OSU Education Hall Interior Renovation
FFA Project #: 10-98-07

Item Name: Sofa

Location: Per plan

Unit Quantity: 2 (Vendor to verify quantity)

Description:

Manufacturer: Davis

Model: Kontour Lounge; KT-2000; Two Seater / Straight / Full Back

Dimensions: 60.5"W x 30.375"D x 29.375"H x 16.75"SH

Construction: CNC hardwood plywood, Multi-density foam with Dacron overlay. Back and seat sections are bolted together. Solid steel legs.

Leg Finish: MS – Matte Silver

Glides: Heavy-duty glides for carpet/tile/resilient floors

Fabric: (COM)

Manufacturer: Arc-Com

Pattern: Task Force; Sierra; AC-68084

Color: Espresso #15

Width: 54"

Repeat: Random

Content: 42% Polyester, 42% Polyacrylic, 16% Cotton

Finish/Backing: Add Nano-Tex with DuraBlock

Durability: Exceeds 90,000 double rubs

Yardage per unit: (Verify)

Installation: Do not railroad fabric

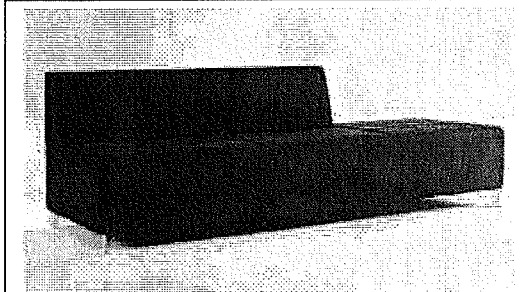

SIMILAR (2 SEAT W/ FULL BACK)

Item Notes:

Provide finish submittals for Architect's review prior to fabrication.

Item Code:

SOFA CH-11B

Project: OSU Education Hall Interior Renovation
FFA Project #: 10-98-07
FFA Contact: Brenda Katz, FFA
Client Contact: Kristin Kinman, OSU

Item Name: Sofa

Location: Per plan

Unit Quantity: 1 (Vendor to verify quantity)

Description:

Manufacturer: Davis

Model: Kontour Lounge; KT-2000; Two Seater / Straight / Full Back

Dimensions: 60.5"W x 30.375"D x 29.375"H x 16.75"SH

Construction: CNC hardwood plywood, Multi-density foam with Dacron overlay. Back and seat sections are bolted together. Solid steel legs.

Leg Finish: MS – Matte Silver

Glides: Heavy-duty glides for carpet/tile/resilient floors

Fabric: (COM)

Manufacturer: HBF

Pattern: Moss

Color: 869-39 Loam

Width: 54"

Repeat: Random

Content: 54% Acrylic, 38% Polyester, 8% Cotton

Finish/Backing: Add Nano-Tex with DuraBlock

Durability: Exceeds 99,000 double rubs

Yardage per unit: (Verify)

Installation: Do not railroad fabric

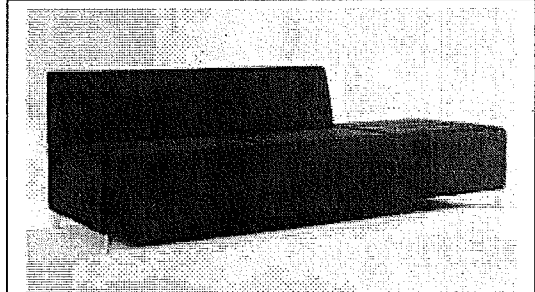

SIMILAR (2 SEAT W/ FULL BACK)

Item Notes:

Provide finish submittals for Architect's review prior to fabrication.

ITEM 10

OSU Education Hall Interior Renovation Item Specification

Item Code:

SOFA CH-12A

Project: OSU Education Hall Interior Renovation
FFA Project #: 10-98-07

Item Name: Sofa

Location: Per plan

Unit Quantity: 1 Each Hand (2 total)
(Vendor to verify configuration & quantity)

Description:

Manufacturer: Davis

Model:

Kontour Lounge; KT-3100-L; Three Seater / 2/3 Back (Qty. 1)

Kontour Lounge; KT-3100-R; Three Seater / 2/3 Back (Qty. 1)

Dimensions: 89.5"W x 30.375"D x 29.375"H x 16.75"SH

Construction: CNC hardwood plywood, Multi-density foam with Dacron overlay. Back and seat sections are bolted together. Solid steel legs.

Leg Finish: MS – Matte Silver

Glides: Heavy-duty glides for carpet/tile/resilient floors

Fabric: (COM)

Manufacturer: Maharam, Kvadrat

Pattern: Divina Melange 460830

Color: 280

Width: 59"

Repeat: None

Content: 100% Wool

Finish/Backing: Add Nano-Tex with DuraBlock

Durability: Exceeds 45,000 double rubs

Yardage per unit: (Verify)

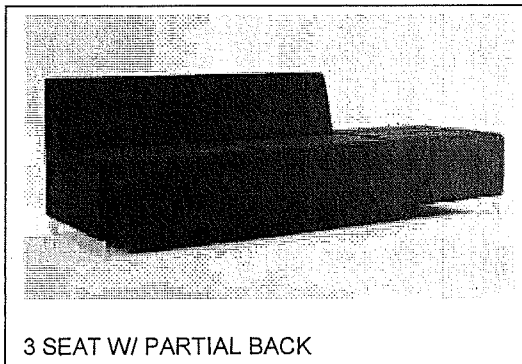

Item Notes:

Provide finish submittals for Architect's review prior to fabrication.

Item Code:

SOFA CH-12B

Project: OSU Education Hall Interior Renovation
FFA Project #: 10-98-07
FFA Contact: Brenda Katz, FFA
Client Contact: Kristin Kinman, OSU

Item Name: Sofa

Location: Per plan

Unit Quantity: 1 (Vendor to verify configuration & quantity)

Description:

Manufacturer: Davis

Model:

Kontour Lounge; KT-3100-R; Three Seater / 2/3 Back

Dimensions: 89.5"W x 30.375"D x 29.375"H x 16.75"SH

Construction: CNC hardwood plywood, Multi-density foam with Dacron overlay. Back and seat sections are bolted together.

Solid steel legs.

Leg Finish: MS – Matte Silver

Glides: Heavy-duty glides for carpet/tile/resilient floors

Fabric: (COM)

Manufacturer: Maharam, Kvadrat

Pattern: Divina 460730

Color: 181

Width: 59"

Repeat: None

Content: 100% Wool

Finish/Backing: Add Nano-Tex with DuraBlock

Durability: Exceeds 45,000 double rubs

Yardage per unit: (Verify)

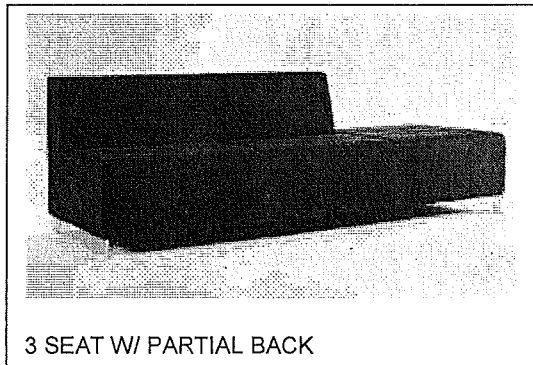

3 SEAT W/ PARTIAL BACK

Item Notes:

Provide finish submittals for Architect's review prior to fabrication.

ITEM 11

OSU Education Hall Interior Renovation Item Specification

Item Code:

BENCH CH-13

Project: OSU Education Hall Interior Renovation
FFA Project #: 10-98-07

Item Name: Bench

Location: Per plan

Unit Quantity: 2 (Vendor to verify quantity)

Description:

Manufacturer: Hightower Group

Model: Plasma Grande

Dimensions: 140"L x 28.5"D x 15.5"H

Contrasting Thread Color:

Pantone, Process Color System; S 325-1

Glides: Heavy-duty glides for tile and resilient floors

Fabric: (COM)

Manufacturer: Maharam, Kvadrat

Pattern: Divina 460730

Color: 552

Width: 59"

Repeat: None

Content: 100% Wool

Finish/Backing: Add Nano-Tex with DuraBlock

Durability: Exceeds 45,000 double rubs

Yardage per unit: (Verify)

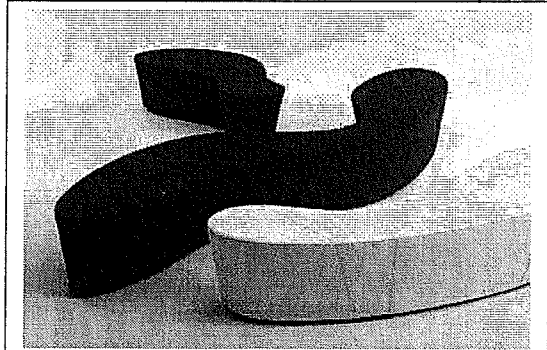

LARGE BENCH

Item Notes:

Provide finish submittals for Architect's review prior to fabrication.

ITEM 12

OSU Education Hall Interior Renovation Item Specification

Item Code:

BENCH CH-14A

Project: OSU Education Hall Interior Renovation
FFA Project #: 10-98-07

Item Name: Bench

Location: Per plan

Unit Quantity: 1 (Vendor to verify quantity)

Description:

Manufacturer: Hightower Group

Model: Plasma

Dimensions: 65"L x 28.5"D x 15.5"H

Contrasting Thread Color:

Pantone, Process Color System; S 62-1

Glides: Heavy-duty glides for tile and resilient floors

Fabric: (COM)

Manufacturer: Maharam, Kvadrat

Pattern: Divina Melange 460830

Color: 280

Width: 59"

Repeat: None

Content: 100% Wool

Finish/Backing: Add Nano-Tex with DuraBlock

Durability: Exceeds 45,000 double rubs

Yardage per unit: (Verify)

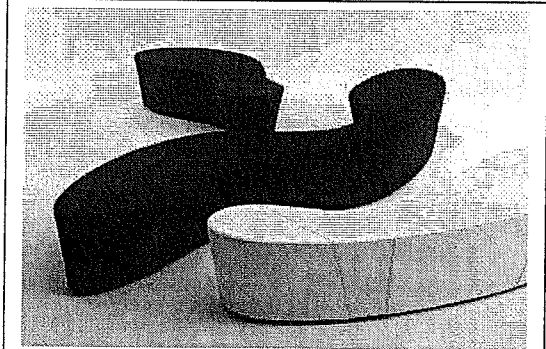

SMALL BENCH

Item Notes:

Provide finish submittals for Architect's review prior to fabrication.

Item Code:

BENCH CH-14B

Project: OSU Education Hall Interior Renovation
FFA Project #: 10-98-07
FFA Contact: Brenda Katz, FFA
Client Contact: Kristin Kinman, OSU

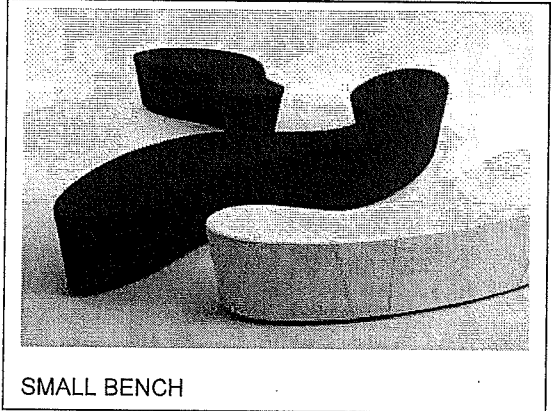

Item Name: Bench
Location: Per plan
Unit Quantity: 1 (Vendor to verify quantity)

Description:
Manufacturer: Hightower Group
Model: Plasma
Dimensions: 65"L x 28.5"D x 15.5"H
Contrasting Thread Color:
Pantone, Process Color System; S 62-1
Glides: Heavy-duty glides for tile and resilient floors

Fabric: (COM)
Manufacturer: Maharam, Kvadrat
Pattern: Divina 460730
Color: 181
Width: 59"
Repeat: None
Content: 100% Wool
Finish/Backing: Add Nano-Tex with DuraBlock
Durability: Exceeds 45,000 double rubs
Yardage per unit: (Verify)

Item Notes:

Provide finish submittals for Architect's review prior to fabrication.